

# Accutom-100

## Instruction Manual

Manual No.: **16177025-04**  
Revision **A**

Date of release **YYYY.MM.DD**

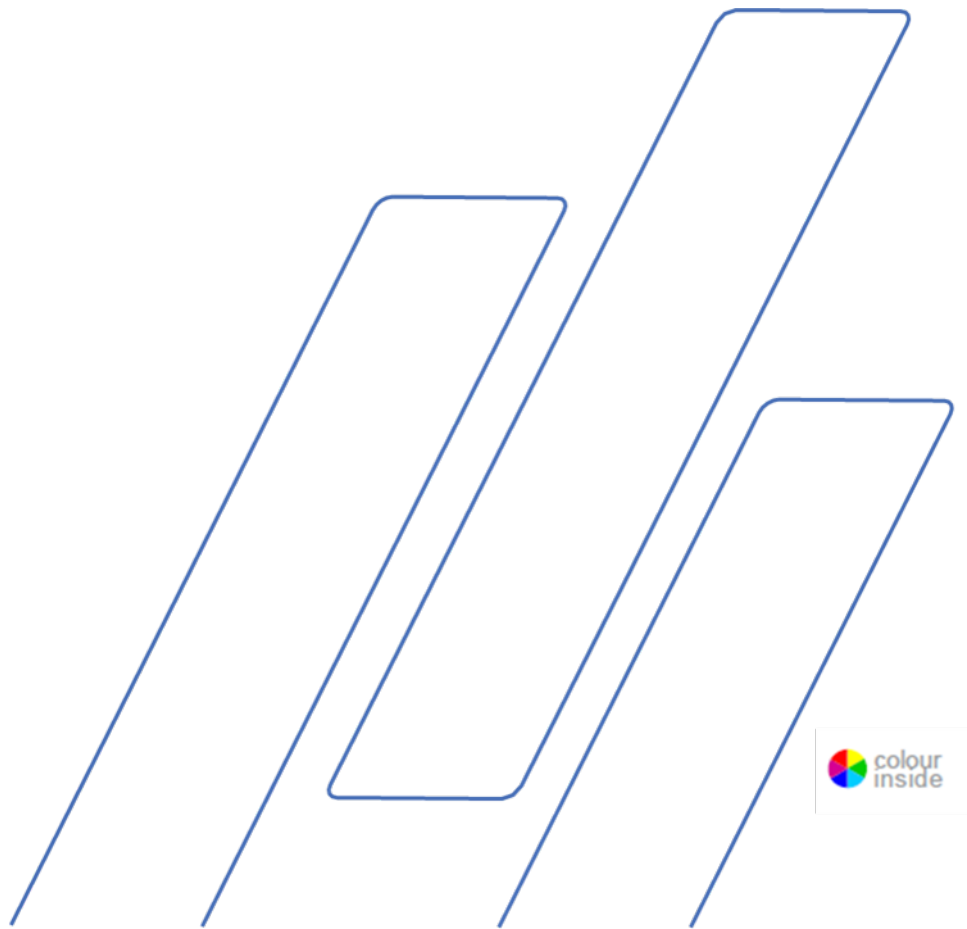



<b>Table of Contents</b>	<b>Page</b>
Intended use .....	2
Safety Precaution Sheet.....	4
User's Guide .....	8
Reference Guide .....	81
Appendix: .....	109
Accutom-10/-100, Pre-Installation Checklist.....	110
Declaration of Conformity .....	118

## **Intended use**

For professional, automatic, materialographic cutting or grinding of materials for further materialographic inspection. Only to be operated by skilled/trained personnel.

The machine is designed only to be used with Struers consumables specially designed for this purpose and this type of machine.

The machine is for use in a professional working environment (e.g. a materialographic laboratory).

### **Do not use the machine for:**

Cutting or grinding of materials other than solid materials suitable for materialographic studies. In particular, the machine must not be used for any type of explosive and/or flammable material, or materials which are not stable during machining, heating or pressure.

The machine may not be used with cut-off wheels which are not compatible with the machine requirements (e.g. toothed cut-off wheels).

### **Models:**

## **Accutom-100**



### **NOTE:**

READ the instruction manual carefully before use.

Keep a copy of the manual in an easy-to-access place for future reference.

Always state *Serial No* and *Voltage/frequency* if you have technical questions or when ordering spare parts. You will find the *Serial No.* and *Voltage* on the type plate of the machine itself. We may also need the *Date* and *Article No* of the manual. This information is found on the front cover.

The following restrictions should be observed, as violation of the restrictions may cause cancellation of Struers legal obligations:  
**Instruction Manuals:** Struers Instruction Manual may only be used in connection with Struers equipment covered by the Instruction Manual.

Struers assumes no responsibility for errors in the manual text/illustrations. The information in this manual is subject to changes without notice. The manual may mention accessories or parts not included in the present version of the equipment.

The contents of this manual are the property of Struers. Reproduction of any part of this manual without the written permission of Struers is not allowed.

All rights reserved. © Struers 2019.

**Struers**  
Pederstrupvej 84  
DK 2750 Ballerup  
Denmark  
Telephone +45 44 600 800  
Fax +45 44 600 801

---



## **Safety Precaution Sheet<sup>1</sup>** **Read carefully before use**

1. Ignoring this information and mishandling of the equipment can lead to severe bodily injuries and material damage.
2. The machine must be installed in compliance with local safety regulations. All functions on the machine and any connected equipment must be in working order.
3. The operator(s) must read the Safety and User's Guide sections of this manual and the relevant sections of the manuals for any connected equipment and accessories. The operator(s) must read the Instructions for Use and, where applicable, Safety Data Sheets for the applied consumables.
4. This machine is to be operated and maintained by skilled/trained personnel only.
5. Use only intact cut-off wheels. Cut-off wheels must be approved for min. 5,000 rpm.
6. The machine must be placed on a safe and stable table with an adequate working height able to carry the machine and supplementary accessories and consumables.
7. Operators should ensure that the actual voltage corresponds to the voltage on the rear of the machine. The machine must be earthed. Follow the local regulations. Always turn the power off and remove the plug or the cable before dismantling the machine or installing additional components.
8. Consumables: only use consumables specifically developed for use with this type of materialographic machine.
9. Observe the current safety regulations for handling, mixing, filling, emptying and disposal of the additive for cooling fluid. Avoid skin contact with the additive for cooling fluid.
10. Mind the protruding safety catch when the guard is raised.
11. The workpiece must be securely fixed in a clamping device.
12. Use of working gloves is recommended as the specimen may be both very hot and have sharp edges.

---

<sup>1</sup> From Safety Precaution Sheet, Revision B

*Accutom-100*  
*Instruction Manual*

13. Use of safety goggles is recommended when using the flushing hose. Only use the flushing hose for cleaning inside the cutting chamber.
14. If you observe malfunctions or hear unusual noises - stop the machine and call technical service.
15. The machine must be disconnected from the mains prior to any service. Wait 15 minutes until residual potential on the capacitors is discharged.
16. Do not cycle mains power more than once every three minutes. Damage to the drive will result.
17. In case of fire, alert bystanders, the fire brigade and cut power. Use a powder fire extinguisher. Do not use water.

---

The equipment should only be used for its intended use and as detailed in the Instruction Manual.

The equipment is designed for use with consumables supplied by Struers. If subjected to misuse, improper installation, alteration, neglect, accident or improper repair, Struers will accept no responsibility for damage(s) to the user or the equipment.

Dismantling of any part of the equipment, during service or repair, should always be performed by a qualified technician (electromechanical, electronic, mechanical, pneumatic, etc.).

---

## Icons and typography

Stuers uses the below icons and typographical conventions. A list of the Safety Messages used in this manual can be found in the chapter on [Cautionary Statements](#).

Always consult the Instruction Manual for information on the potential hazards marked by the icons fixed to the machine.

### Icons and Safety Messages



#### **ELECTRICAL HAZARD**

indicates an electrical hazard which, if not avoided, will result in death or serious injury.



#### **DANGER**

indicates a hazard with a high level of risk which, if not avoided, will result in death or serious injury.



#### **WARNING**

indicates a hazard with a medium level of risk which, if not avoided, could result in death or serious injury.



#### **CAUTION**

indicates a hazard with a low level of risk which, if not avoided, could result in minor or moderate injury.



#### **CRUSHING HAZARD**

indicates a crushing hazard which, if not avoided, could result in minor, moderate or serious injury.



#### **EMERGENCY STOP**



## General Messages



### **NOTE**

indicates a risk of damage to property, or the need to proceed with special care.



### **HINT**

indicates additional information and tips.

## Colour Inside Logo



The 'colour inside' logo on the cover page of this Instruction Manual indicates that it contains colours which are considered to be useful for the correct understanding of its contents.

Users should therefore print this document using a colour printer.

## Typographic conventions

<b>Bold type</b>	indicates button labels or menu options in software programs
<i>Italic type</i>	indicates product names, items in software programs or figure titles
<u>Blue text</u>	indicates a link to another section or webpage
■ Bullets	indicates a necessary work step

# User's Guide

Table of Contents	Page
<b>1. Getting Started</b>	
Device Description .....	11
Checking the Contents of Packing.....	12
Unpacking Accutom .....	12
Placing Accutom .....	13
Recommended workbench dimensions .....	13
Recommended Space.....	13
Getting Acquainted with Accutom.....	14
Front of Accutom .....	15
Rear of Accutom .....	15
Inside the Chamber.....	16
Safety Lock.....	17
Supplying Power .....	18
Power Socket .....	18
Single-phase Supply .....	18
3-phase Supply .....	18
Connection to the Machine .....	18
Filling the Recirculation Tank with Cooling Fluid.....	19
Water Sensitive Materials .....	19
Optimising Cooling .....	20
Flushing Hose .....	21
Debris Collection .....	22
Noise Level.....	22
Handling noise (during operation).....	22
Mounting a Cut-off Wheel .....	23
Mounting a Cup Wheel.....	25
Mounting a Specimen Holder.....	27
Connecting a Vacuum Chuck to the Vacuum System.....	27
(Optional accessory) .....	27
<b>2. Basic Operation</b>	
Front Panel.....	28
Front Panel Controls .....	29
Reading the Display .....	30
Manoeuvring in the Menu Structure .....	31
Acoustic Signals .....	31
Standby Mode.....	31
Software Settings .....	32
Zero Positions.....	33
Changing the Language .....	33
Editing Numeric Values .....	34
Editing Alphanumeric Values .....	35
Main menu.....	36
Editing a Method .....	37

Cutting Method Parameters .....	38
Cut-off wheel .....	39
MultiCut .....	40
(Accutom-100 only) .....	40
Return position .....	40
Cutting Force Level .....	41
Grinding Methods Parameters .....	41
Cup wheel .....	42
Positioning Keys .....	43
Setting Relative Zero Position .....	43
Moving to Relative Zero Position .....	44
Starting a Cutting Process .....	45
Clamping the Workpiece .....	45
Positioning the Workpiece .....	45
The Cutting Process Screen .....	46
Feed speed .....	46
Wheel speed .....	46
Length of cut .....	46
Motor load .....	47
MultiCut .....	47
Timer Countdown .....	47
Manual Stop .....	47
Re-starting cutting .....	47
Changing Parameters During Cutting .....	47
Retracting the Workpiece .....	47
<i>OptiFeed</i> .....	47
Starting a Grinding Process .....	48
Clamping the Specimen .....	48
Positioning the Specimen .....	48
The Grinding Process Screen .....	49
Feed speed .....	49
Wheel speed .....	49
Removal .....	49
Motor load .....	50
Timer Countdown .....	50
Manual Stop .....	50
Re-starting grinding .....	50
Changing Parameters During Grinding .....	50
Retracting the Specimen .....	50
<i>OptiFeed</i> .....	50

### 3. Advanced Operation

Maintenance Menu .....	51
Service functions Menu .....	51
Reset functions Menu .....	51
Clean cutting track .....	51
Configuration Menu .....	52
Options Menu .....	52
Changing Operation Mode .....	53
New Pass Code .....	54
Creating a User Defined Cut-off Wheel in the Database .....	54

Creating a User Defined Cup Wheel in the Database.....	55
Cutting Method Parameters.....	56
Holder Rotation.....	57
MultiCut Equal size.....	58
MultiCut Different Sizes.....	59
Cutting Force Level:.....	60
Optimising the Cutting Results.....	60
Grinding Method Parameters.....	61
Holder Rotation.....	62
Positioning mode.....	62
Grinding Thin Sections.....	64
Preparing the Glass Slides.....	64
Grinding the Specimen.....	64
Grinding length.....	65

#### **4. Maintenance**

General Cleaning.....	66
Daily Inspection.....	66
Checking the Guard.....	66
Checking the Safety Lock.....	66
Daily Maintenance.....	67
Machine.....	67
Weekly.....	68
Cleaning the Cutting Chamber.....	68
Checking the Cooling Fluid Tank.....	69
Cooling Fluid Nozzles.....	69
Tube for Water-free Cooling Fluid.....	69
Cleaning the Cooling Fluid Tank.....	70
Yearly.....	71
Inspection of Guard.....	71
Replacing the Guard.....	71
Testing Safety Devices.....	71
Emergency Stop.....	71
Safety lock.....	72
Hold-to-run Button.....	72
Spare Parts.....	72
Maintenance of Cut-off Wheels and Cup Wheels.....	73
Abrasive Cut-off Wheels.....	73
Diamond and CBN Cut-off Wheels.....	73
Dressing Diamond and CBN Cut-off Wheels.....	74
Testing Cut-off Wheels.....	74
Changing Cooling Pump Tubes.....	75
Spare Parts.....	76

<b>5. Cautionary Statements</b> .....	77
---------------------------------------	----

<b>6. Transport and Storage</b> .....	79
---------------------------------------	----

<b>7. Disposal</b> .....	80
--------------------------	----

## **1. Getting Started**

### **Device Description**

Accutom-100 is an automatic cut-off machine for cutting and grinding of the majority of solid and stable (non-explosive) materials. It has Y-movement of the cut-off wheel, a motorized X-arm and a built-in recirculation cooling unit. The cut-off wheel and X-arm can only be moved either when the guard is closed or holding the hold-to-run button when using the positioning keys.

The operator selects and mounts the cut-off wheel / cup wheel and enters the process parameters.

The operator mounts the workpiece in the clamping tool. Then, the clamping tool is mounted directly to the cutting arm via a dovetail connection.

The guard locks when the operator starts the machine. It remains locked until all movements are stopped, and the cut-off wheel/cup wheel is in the selected stop position.

The specimens can become hot during the process. It is recommended to wear gloves when handling the processed specimens.

It is recommended to connect Accutom-100 to an external exhaust system to remove fumes from the process.

In case of power-loss during the process, the guard remains locked. Use the special key to release the lock and open the guard.

The emergency stop cuts the power to all moving parts. The guard can be opened, when the emergency stop is released.

## Checking the Contents of Packing

In the packing box you will find the following parts:

1	Accutom-100
2	Mains cables
1	Triangle key for safety lock release
1	Support pin
1	Socket spanner, 17mm
1	Tray (with paper)
1	Allen key, 3 mm
1	Brush (for cleaning)
1	Hose for connection to exhaust, 51 mm dia., 2 m
1	Hose clamp, 40-60 mm dia.
1	Flange screw for Cup Wheel
1	Long nozzle screw for cup wheel
1	Instruction Manual set

## Unpacking Accutom



### NOTE:

Always lift Accutom from underneath the machine

A crane and two lifting straps<sup>2</sup> are required to lift Accutom off the shipment pallet.

Before lifting Accutom into position:

- Remove the screws around the base of the packing crate and lift the entire upper part of the crate.
- Remove the metal brackets securing Accutom to the pallet (a 4 mm Allen key is required to remove the 8 screws that secure the metal brackets).
- Remove the recirculation tank.
- Place the two lifting straps under Accutom.
- Position the straps under Accutom, so that they are on the inside of the feet. See drawing.

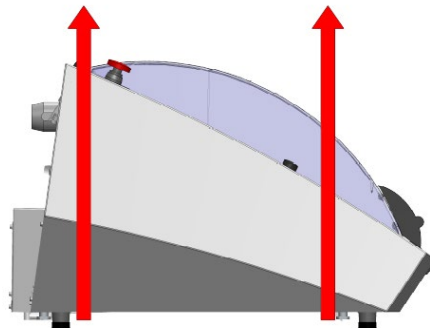

- Use straps which are long enough so that they do not place stress on the guard (use straps of approx. 3-3½ m in length).

<sup>2</sup> Crane and straps must be approved for at least twice the weight of the load.

- A lifting bar is recommended so that the two straps are kept apart below the lifting point.
- Lift Accutom onto the table.
- Lift the front of Accutom and carefully move into place.



### CRUSHING HAZARD

Take care not to trap fingers when handling the machine.  
Wear safety shoes when handling heavy machinery.



### HINT:

Store the packing crate, bolts and brackets for use whenever Accutom is transported/re-located.  
Failure to use the original packaging and fittings could cause severe damage to the machine and will void the warranty.

## Placing Accutom

- The machine must be placed on a safe and stable table with an adequate working height and which is able to carry the machine and supplementary accessories and consumables.
- Ensure that the work station has adequate lighting. Avoid direct glare (dazzling light sources within the operator's line of vision) and reflected glare (reflections of light sources).

### Recommended workbench dimensions

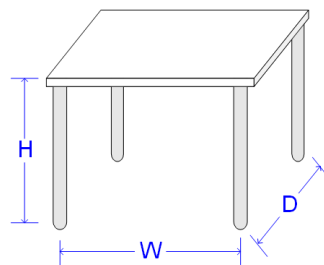

Height: Recommended 80 cm / 31.5"  
Width: min. 70 cm / 27.6"  
Depth: min. 80 cm / 31.5"

- Check that the Accutom is resting securely with all 4 rubber feet on the table.  
(For greatest accuracy, the machine must be completely level - tolerance  $\pm 1$  mm).
- The machine must be close to the power supply.
- The machine must be operated in a well-ventilated room or connected to an exhaust system.

## Recommended Space

To facilitate easy access for servicing, allow sufficient space around the machine.

## Getting Acquainted with Accutom

Take a moment to familiarise yourself with the location and names of the Accutom components.

### MAIN SWITCH

The main switch is located at the rear of Machine.



The EMERGENCY STOP is located on the front of the machine.

Emergency Stop

- Push the red button to Activate.
- Turn the red button clockwise to Release.

**NOTE:**

Do not use the Emergency stop for operational stop of the machine during normal operation.

BEFORE releasing (disengaging) the Emergency stop, investigate the reason for activating the Emergency stop and take any necessary corrective action.



Accutom-100  
Instruction Manual

Front of Accutom

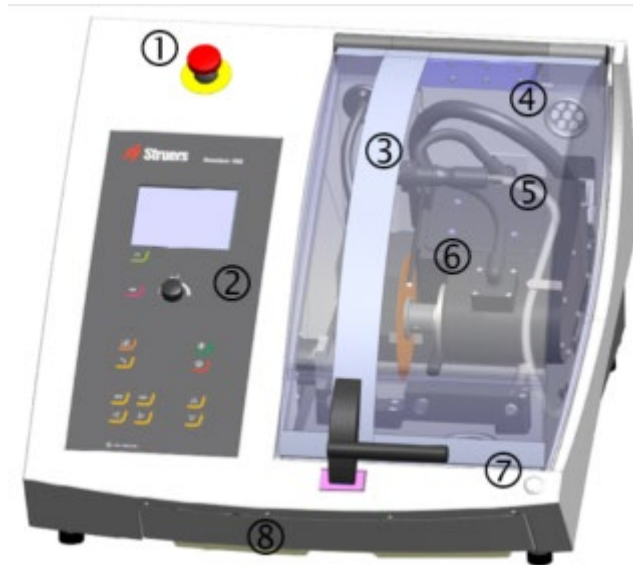

- |   |                      |
|---|----------------------|
| ① Emergency Stop  | ⑤ Flushing Hose      |
| ② <a href="#">Front Panel</a> (Details in section 2. Basic Operation) | ⑥ Cutting motor      |
| ③ Guard   | ⑦ Hold-to-run button |
| ④ Exhaust   | ⑧ Cooling fluid tank |

Rear of Accutom

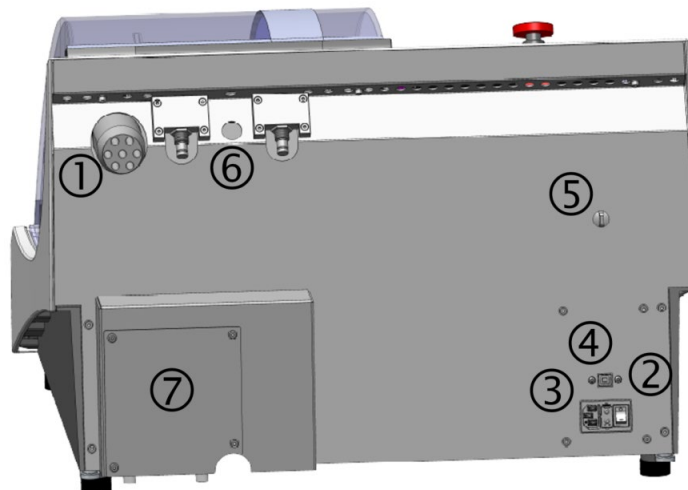

- |                    |                                |
|--------------------|--------------------------------|
| ① Exhaust          | ⑤ Vacuum connection (plug)     |
| ② Main switch      | ⑥ Hinges                       |
| ③ Mains connection | ⑦ Cover for recirculation pump |
| ④ Service socket   |                                |

Inside the Chamber

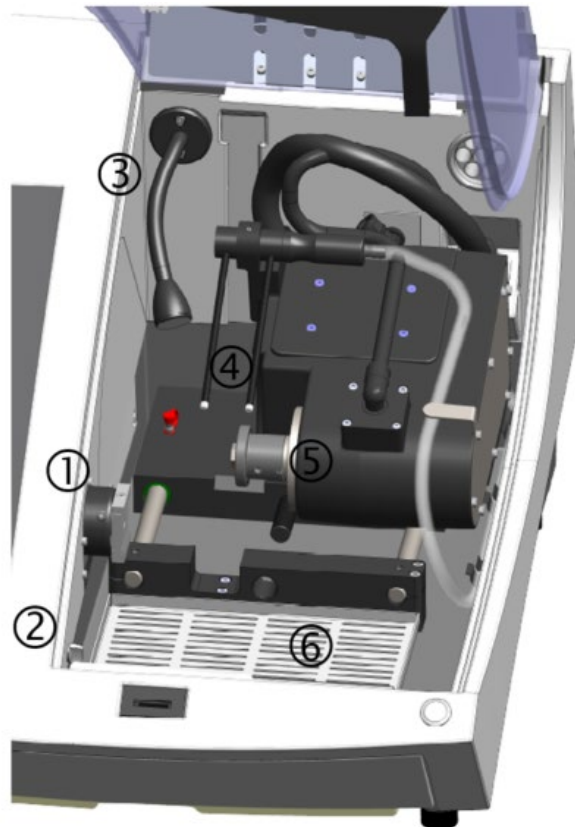

- |                       |                              |
|-----------------------|------------------------------|
| ① Specimen holder arm | ④ Cooling nozzles            |
| ② Vacuum connection   | ⑤ Wheel spindle              |
| ③ Flexible LED light  | ⑥ Tray for cut off specimens |

## Safety Lock



**NOTE:**

The guard on Accutom can only be opened when the machine is connected to a power supply and the main power switch is on.

To open the guard if the power is not connected:

- Remove the Cooling fluid tank.

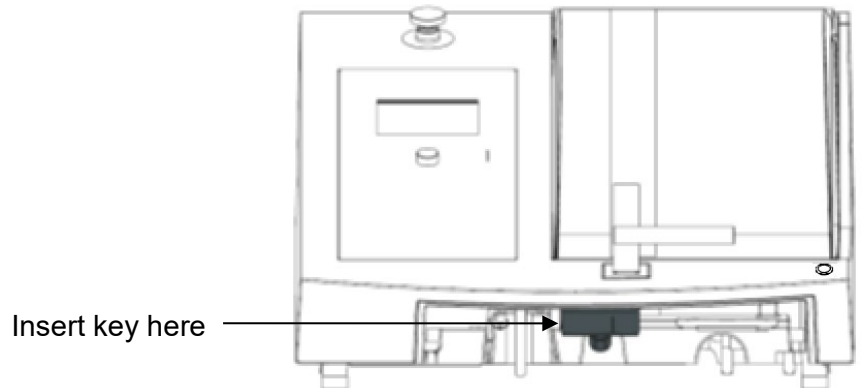

- Use the triangle key (supplied) to de-activate the safety lock. Turn the key 180°. **Do not use force!**



**HINT:**

Remember to re-activate the safety lock release before operating Accutom.

## Supplying Power



### ELECTRICAL HAZARD

Switch the power off when installing electrical equipment.  
The machine must be earthed (grounded).  
Check that the mains voltage corresponds to the voltage stated on the type plate on the side of the machine.  
Incorrect voltage may result in damage to the electrical circuit.

### Power Socket

The mains power socket must be easily accessible and located between 0.6 m - 1.9 m (2½" – 6') above floor level. (An upper limit of 1.7 m (5' 6") is recommended).

Accutom is shipped with 2 types of Mains cables:

### Single-phase Supply

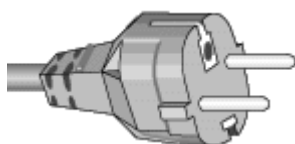

The 2-pin (European Schuko) plug is for use on single-phase connections.

If the plug supplied on this cable is not approved in your country, then the plug must be replaced with an approved plug. The leads must be connected as follows:

Yellow/green:	earth (ground)
Brown:	line (live)
Blue:	neutral

### 3-phase Supply



The 3-pin (North American NEMA) plug is for use on 3-phase power connections.

If the plug supplied on this cable is not approved in your country, then the plug must be replaced with an approved plug. The leads must be connected as follows:

Green:	earth (ground)
Black:	line (live)
White:	line (live)

### Connection to the Machine



- Connect the power cable to the Machine. (IEC 320 connector).
- Connect to the mains power supply.

## Filling the Recirculation Tank with Cooling Fluid

The Accutom has a built-in cooling fluid system. The fluid coming from the nozzles passes over the cut-off wheel/ cup wheel and collects in the drain in the chamber; where it then returns to the tank, which is located under the chamber.



### CAUTION

Read the Safety Data Sheet for the additive for cooling fluid before use.

Avoid skin contact with the additive for cooling fluid.

Use of gloves and safety goggles is recommended.

- With the tank in position under the chamber.  
Fill the tank by pouring a **4% solution** of Struers additive, Cooli Additive: **190 ml Cooli Additive and 4.5 l water** through the hole in the base of the chamber.  
For water-sensitive materials, use Struers Water-Free Cooling Fluid.



### NOTE:

Take care not to overfill the tank!



### HINT:

It is very important that **the concentration of the Cooli Additive in the cooling fluid is between 3 % and 6%.**

Check the concentration of Cooli Additive with a refractometer.

**Cooli Additive concentration = 2.4 x °Brix value.**

## Water Sensitive Materials

Struers Water-free Cutting Fluid is available for cutting water sensitive materials.



### NOTE:

The tube in the cooling fluid pump **MUST** be replaced by a special tube when using Water-free Cutting Fluid. The standard tube will only last for a few days as it will react with the Water-free Cutting Fluid.

Tubes for Water-free Cutting are available as an accessory (Cat.no.: 05996921).

For instructions on exchanging the tube, please see the section on [Changing Cooling Pump Tubes](#) in the **Maintenance** section of the manual.

## Optimising Cooling

Sufficient cooling is very important for ensuring the best cutting quality and to avoid burning of the workpiece and damaging the cut-off wheel.

Optimise cooling effect using the following tips:

- Always use additive to protect the cutting machine from corrosion and to improve cutting and cooling qualities.
- Ensure that there is sufficient water in the tank for optimal cooling.
- Maintain the correct concentration of additive in the cooling fluid (percentage stated on the container of the Struers Additive, Cooli Additive).
- Remember to add Struers Additive each time you refill with water. See hint on page [19](#).
- It is recommended to change the cooling fluid at least once a month to prevent the growth of microorganisms.
- Only use Struers' own additives.  
**Do not** use oil, petrol, or turpentine-based additives, as they can affect the tubes for the cooling fluid.

## Flushing Hose

The Accutom comes complete with a flushing system. This enables the chamber to be rinsed clean of any debris discarded during the cutting / grinding process. Flushing is operated through the Control Panel keys and the hold-to-run button.





### CAUTION

Avoid skin contact with the additive for cooling fluid. Always wear gloves and goggles.

**Do not** start the flushing until the flushing hose is pointing into the cutting chamber.

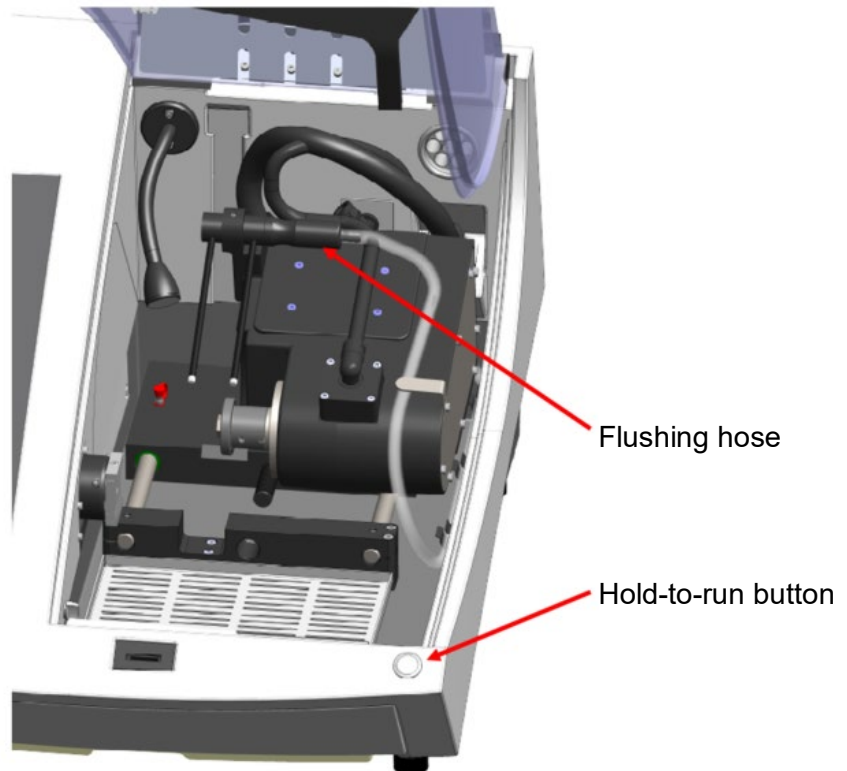
- Remove the hose from the holder.



- Press FLUSH .
- Point the hose into the cutting chamber
- Press and hold the hold-to-run button to start flushing.
- To stop flushing, release hold-to-run button

To start flushing again repeat the steps.



### NOTE:

Remember to replace the hose in its holder when you have finished flushing.

## Debris Collection

Accutom has three systems to keep the debris from polluting the cutting fluid and possibly blocking the nozzles.

- The tray with paper to filter the cutting debris and to collect the cut specimens.
- The basket in the drain that prevents larger pieces from entering the tank.
- The magnet in the tank collects magnetic particles.



### NOTE:

Check the basket and the magnet for cutting debris before starting the cutting process; a blocked drain can result in water overflow and too little water in the tank to secure sufficient cooling.

## Connection to an External Exhaust System

Struers recommends the use of an exhaust system as workpieces may emit harmful gases when cut.

The unit is prepared for connection to an exhaust system via a 50 mm fitting at the rear of the cabinet.

- Mount the exhaust hose onto the ventilation flange at the rear of the machine.
- Connect the exhaust hose to your local exhaust system.

## Noise Level

See [Technical Data](#) in the rear of the Instruction Manual for information on the sound pressure level value.

### *Handling noise (during operation)*

Different materials have different noise characteristics.

Decreasing the rotational speed and/or the force with which the cut-off wheel is pressed against the workpiece, will lower the noise. Processing time may increase.



### CAUTION

Prolonged exposure to loud noises may cause permanent damage to a person's hearing. Use hearing protection if exposure to noise exceeds levels set by local regulations.



## Mounting a Cut-off Wheel

- Lift the guard to the "open" position (the position where it will stay up and open when released).



### CAUTION

Mind the protruding safety catch when the guard is raised.

- Lift the cooling fluid nozzles to gain access to the cut-off wheel mounting.

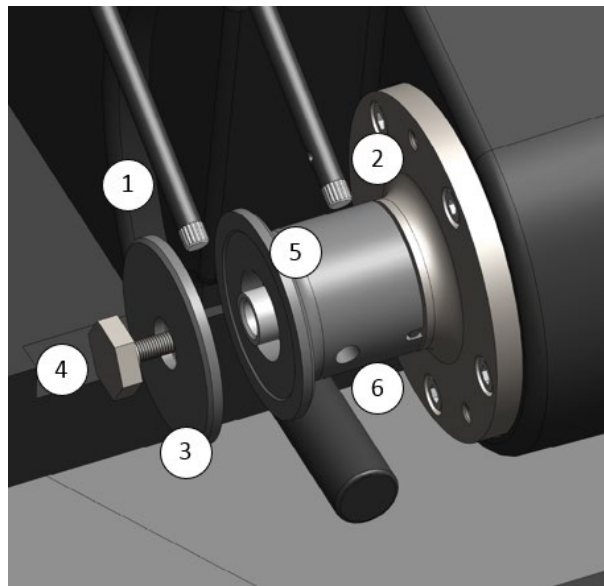

- |                  |                        |
|------------------|------------------------|
| ① Cooling nozzle | ④ Flange screw         |
| ② Cooling nozzle | ⑤ Inner flange         |
| ③ Outer flange   | ⑥ Hole for support pin |

- Insert the support pin into the hole on the wheel spindle.  
Use the socket spanner 17 mm to loosen the flange screw.



### HINT:

The spindle on Accutom has a left-hand thread.

- Remove the outer flange.



### NOTE:

The tolerance between the spindle and inner flange is very small which means that the two surfaces must be absolutely clean. Never try to squeeze the cut-off wheel on as this may damage the spindle or the cut-off wheel. If there are any small burrs, remove them with grinding paper grit size 1200.

- Before mounting the cut-off wheel, test it for damages. See [Testing Cut-off Wheels](#) on page 74.
- Mount the cut-off wheel and hold it flat against the inner flange.

- Remount the outer flange, with the machined face towards the inner flange.
- Mount the flange screw.
- Insert the support pin in the hole in the wheel spindle.
- Gently fasten the flange screw using the socket spanner 17 mm. (The nut should be tightened with a force of maximum 5 Nm / 4 lbf-ft).



**HINT:**

Check that the cut-off wheel is held securely between the inner flange and outer flange.

If the cut-off wheel can be tilted sideways, then it is incorrectly mounted; this will result in uneven wear or breakage.

- Lower the cooling fluid nozzles to their operating positions.

## Mounting a Cup Wheel

A cup wheel Flange Set is required when grinding on Accutom-100. Remove the standard flange set by pulling it away from the wheel spindle and replace with the cup wheel flange set.



**HINT:**

Store the standard flange screw together with the standard flange set.

- Lift the guard to the "open" position (the position where it will stay up and open when released).



**CAUTION**

Mind the protruding safety catch when the guard is raised.



**NOTE:**

The tolerance between the spindle and inner flange is very small which means that the two surfaces must be absolutely clean. Never try to squeeze the cup wheel on as this may damage the spindle or the cup wheel. If there are any small burrs, remove them with grinding paper grit size 1200.

- Lift the cooling fluid nozzles to gain access to the cup wheel mounting.
- Slide the inner flange on the spindle until the spindle end is visible and position the cup wheel so that the surface meets with the inner flange.
- Carefully move the cup wheel and inner flange along the spindle.  
**Tip:** Push the cup wheel in the centre; do not hold the edges of the wheel.
- Push the cup wheel until the inner flange is in position, with the positioning pin in the groove.

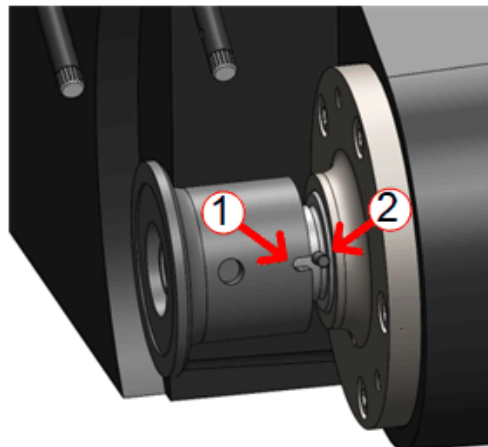

① Groove

② Positioning pin

*Accutom-100*  
*Instruction Manual*

- Remount the outer flange, with the machined face towards the cup wheel.
- Insert the support pin in the hole in the wheel spindle.
- Gently fasten the cup wheel flange screw using the socket spanner 17 mm.  
(The nut should be tightened with a force of maximum 5 Nm / 4 lbf-ft).

During grinding, cooling fluid from the right nozzle is not required.

- Replace the small screw at the end of the right nozzle to the long screw and screw it into the nozzle to stop the flow of cooling fluid.

Nozzle screw

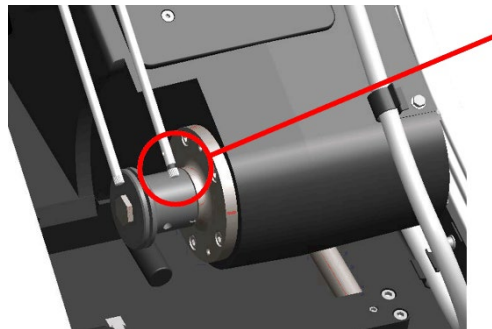

- Lower the cooling fluid nozzles to their operating positions. Make sure that the cooling fluid nozzles do not catch the specimen, if necessary lift the cooling nozzle and angle the hole of the nozzle down.

### Mounting a Specimen Holder

- Clamp the workpiece in a dovetail specimen holder.
- Fasten the specimen holder in the specimen holder arm by sliding the specimen holder into the dovetail fixture and tighten the screw.

### Connecting a Vacuum Chuck to the Vacuum System (Optional accessory)

Before a vacuum chuck is used for the first time, it must be connected to a vacuum pump.

- (For Vacuum Holder CATAP: Remove the narrow vacuum tube from the vacuum chuck.)
- Fit a hose nipple onto the shorter piece of vacuum hose (50 cm).
- Fit the other end of the hose to the vacuum chuck
- Unscrew the small plug on the left of the chamber and connect the vacuum tube by inserting the hose nipple.
- Fit a hose nipple onto the longer piece of vacuum hose (1 m) and connect to a vacuum pump.  
**HINT:** This piece of tube can be shortened to minimize the distance from Accutom-100 to the vacuum pump.
- Connect the other end of the hose to the vacuum inlet on the rear of the machine.



**NOTE:**

Do not use rotation when working with the vacuum holder. The vacuum tube will be wrapped around the holder. Use oscillation instead.



## 2. Basic Operation

This chapter describes the basic operation of the machine. Information on the advanced functions can be found in the [Advanced Operation](#) section of the Instruction Manual.

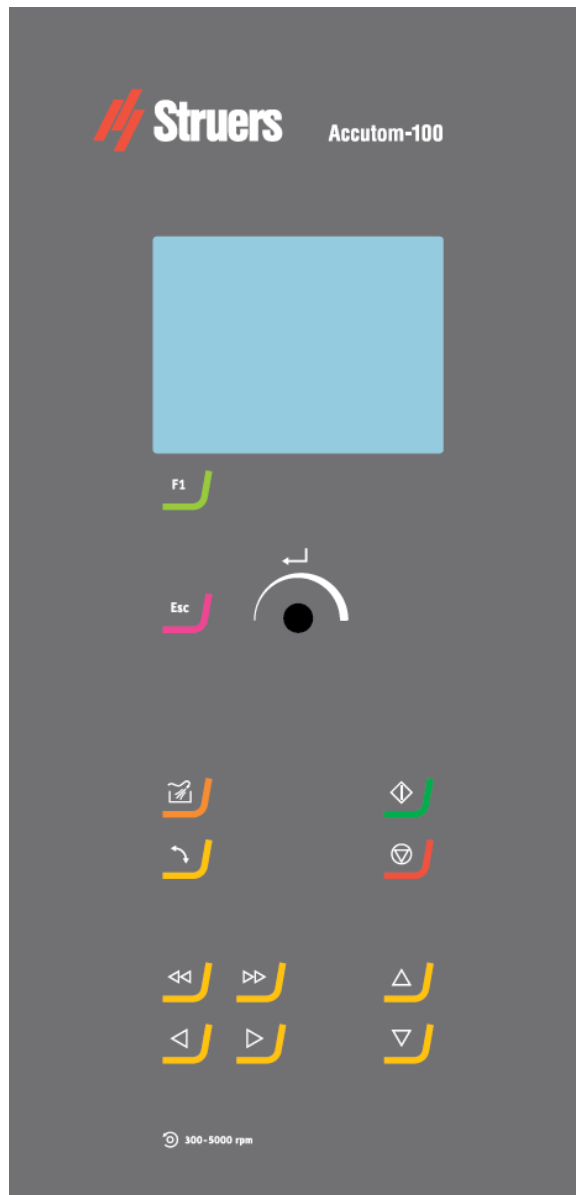
### Front Panel

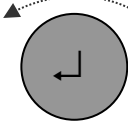

## Front Panel Controls

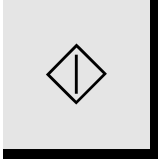
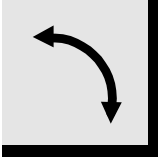
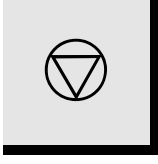
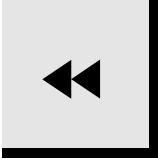
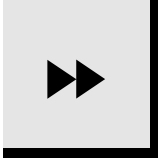
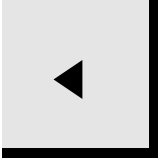
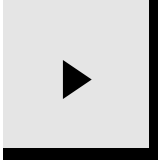
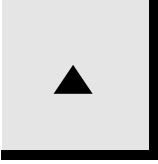
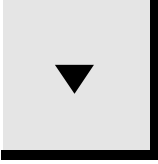
Name	Key	Function	Name	Key	Function
FUNCTION KEY		Menu dependent multi-function key. See the bottom line of the individual screens.	Turn/Push knob		Multifunction knob. Turn knob to move the cursor or to adjust settings. Push knob to select (ENTER)
ESC		Leaves the present menu.			
FLUSH		Starts the flushing operation.	START		Starts the cutting or grinding process according to the pre-set method.
Rotate Holder		Rotates the holder 90° to aid positioning the holder. Keep the key pressed to continuously rotate the holder. Direction of rotation changes each time the key is pressed	STOP		Stops the cutting or grinding process.
FAST POSITION LEFT		Changes to POSITION menu or moves the specimen holder to the left in the X-direction in steps of 100 µm. Keep the key pressed to increase the speed.	FAST POSITION RIGHT		Changes to POSITION menu or moves the specimen holder to the right in the X-direction in steps of 100 µm. Keep the key pressed to increase the speed.
POSITION LEFT		Changes to POSITION menu or moves the specimen holder slowly to the left in the X-direction in steps of 5 µm. Keep the key pressed to increase the speed.	POSITION RIGHT		Changes to POSITION menu or moves the specimen holder slowly to the right in the X-direction in steps of 5 µm. Keep the key pressed to increase the speed.
POSITION UP		Moves the wheel spindle backwards (in the Y-direction) in steps of 100 µm. Keep the key pressed to increase	POSITION DOWN		Moves the wheel spindle forwards (in the Y-direction) in steps of 100 µm. Keep the key pressed to increase the speed.

## Reading the Display

The display on the front panel provides different levels of status information. For example, when the machine is switched on using the Mains switch located at the rear, on the left-hand side of the machine, the display informs you about the physical configuration of the Accutom and the version of software that is installed:



When operating the Accutom, this display is the user-interface to Accutom software.

The display is primarily divided into 2 areas. The position of these areas and the information they contain are explained in the illustration below, which uses a Cutting Method menu as an example:

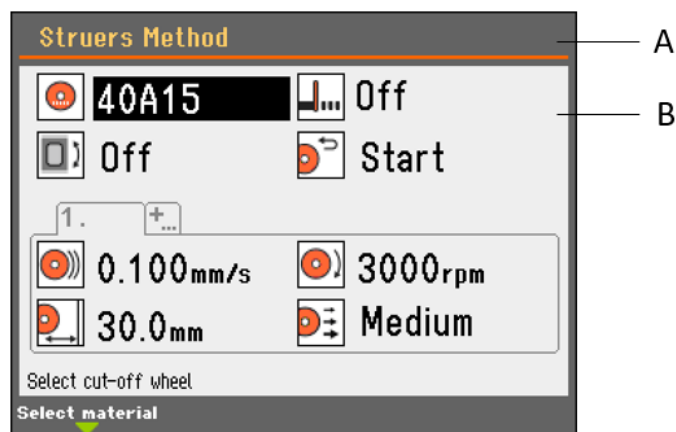

- A** Heading: this is a navigational aid, telling you where you are in the software's hierarchy.
- B** Information fields: these will be either numerical values or text fields, providing information associated with the process shown in the heading. The inverted text shows the cursor position.



*Manoeuvring in the Menu  
Structure*

To select items in the menu:



Turn knob to select a menu, method group or a parameter.



Push knob to open or activate the selection.

**Esc** Press **Esc** to return to the Main menu.

*Acoustic Signals*

When pressing a key, a short beep indicates that the command has been accepted, whereas a long beep indicates that the key cannot be activated now

The 'short' beep can be switched on or off in the *Option menu*.

*Standby Mode*

To increase the lifetime of the display, the backlight is dimmed automatically if Accutom has not been used for 10 min.

- Press any key to re-activate the backlight.

## Software Settings

When switching Accutom on for the first time, the *Select language* screen will appear (to change the language after this, refer to [Changing the Language](#)”).



Turn knob to select the language you prefer.



Push knob to accept the language.

The *Main menu* now appears in the language you have chosen.

During normal operation, immediately after start-up, where the splash screen is displayed, the software goes to the screen that was used before the machine was switched off. Thus, you can continue exactly where you left last time the machine was used. To go to the *Main menu*, use the **Esc** key. The *Main Menu* is the highest level in the menu structure. From this menu, you can enter all the other menus.

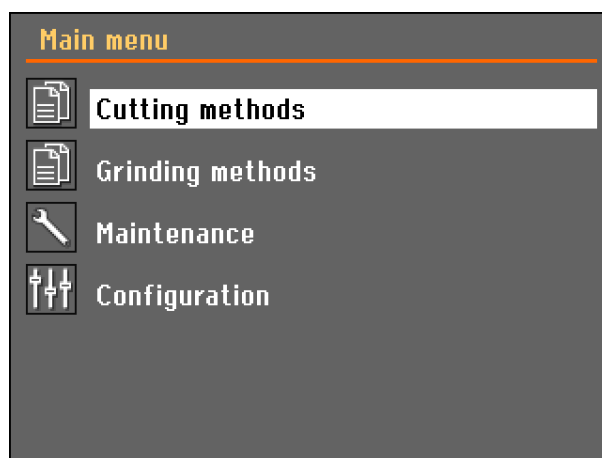

### Zero Positions

Zero positions are calibrated at each start-up, or if reference positions have been lost.

### Changing the Language



Turn the knob to select *Configuration*.



Push knob to activate the *Configuration Menu*.



Push knob to activate the *Options Menu*.



Turn knob to select *Language*.

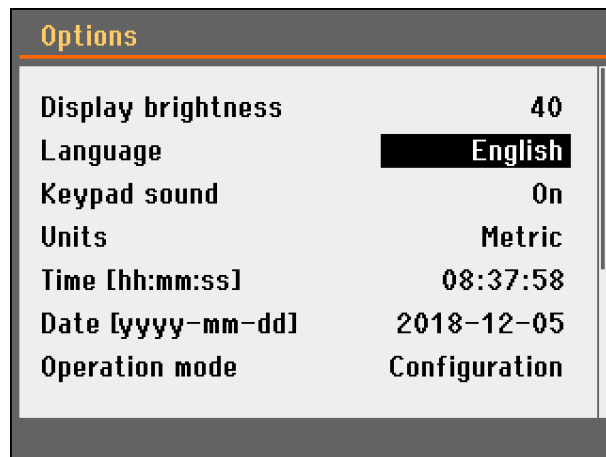

Push knob to activate the *Select language* pop-up menu.



 Turn knob to select the language you prefer.



 Push knob to accept the language.

The *Options* menu now appears in the language you have chosen.

Check if there are any other settings that need changing in the *Option* menu. If not, push **ESC** to return to the main menu.

Otherwise use the Turn/Push knob to select and change the required parameters.

### Editing Numeric Values

 Turn knob to select the value to be changed, e.g. *Wheel speed*:

 Push knob to edit the value.

A scroll box appears around the value.

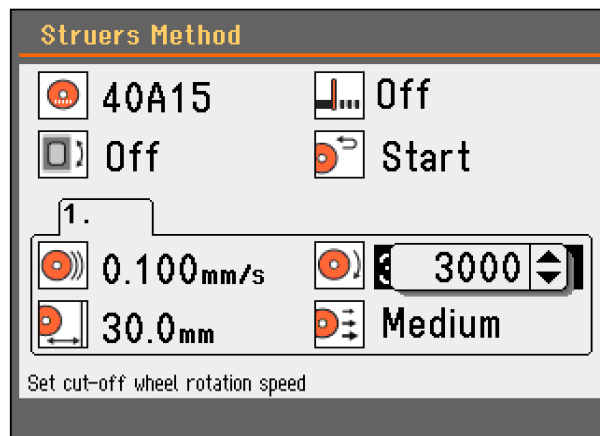

 Turn knob to increase or decrease the numeric value.

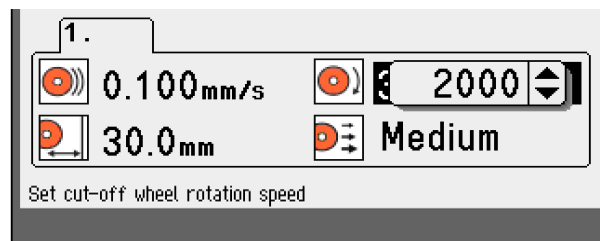

 Push knob to accept the new value.  
(Pressing **Esc** aborts the changes, preserving the original value.)

### Editing Alphanumeric Values



Turn knob to select the alphanumeric value to be changed, e.g. *Return position*

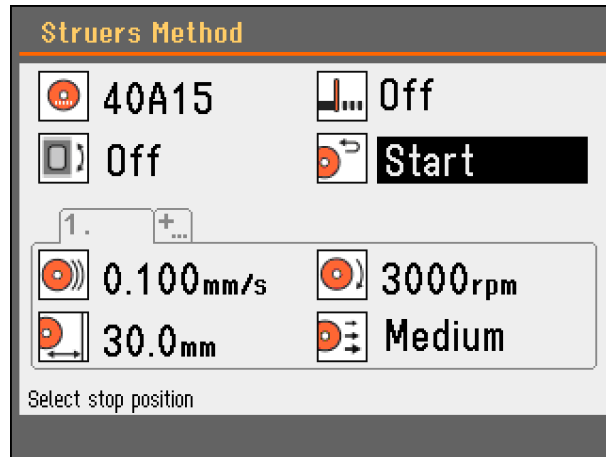

Push knob to edit the value.

A pop-up menu appears.

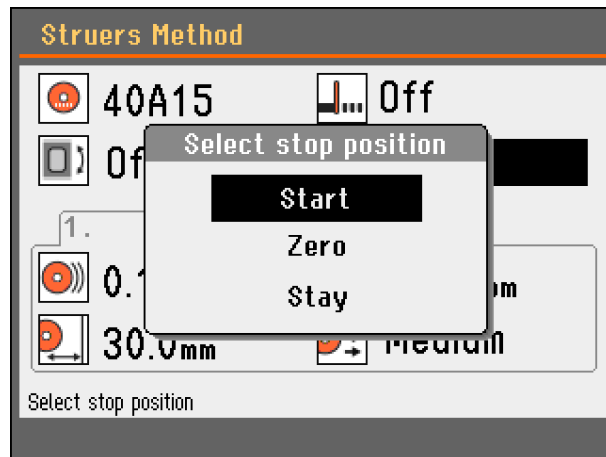

Turn knob to select the correct choice.



Push knob to accept the new selection and to continue or to return to the previous screen.  
(Pressing Esc aborts the changes, preserving the original setting.)



**NOTE:**

If there are only two options, the popup box is not displayed. Pushing the knob (Enter) will toggle between the 2 options.

## Main menu

The *Main menu* is the highest level in the menu structure. From this menu, you can enter the *Cutting methods*, *Grinding methods*, *Maintenance* and *Configuration* menus.

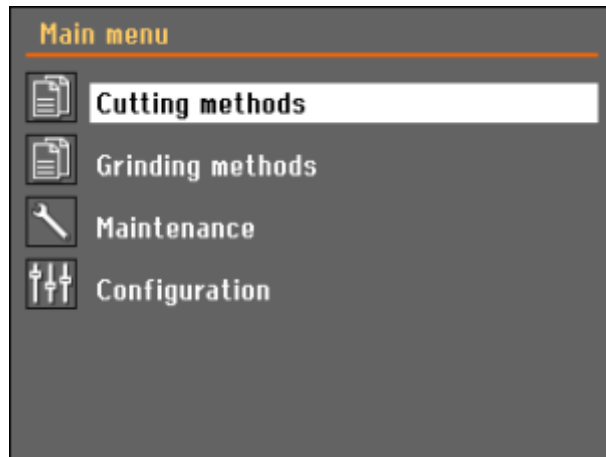

## Editing a Method

From the cutting method screen:

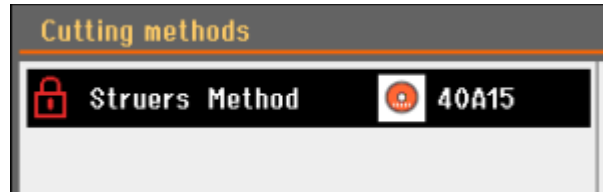

 Press F1

A pop-up menu appears.



 Turn knob to select **Copy**.

↓  
 Push knob to make a copy of the method.



### HINT:

Methods can be locked to prevent making changes.



Please see the section on [Changing Operation Mode](#), later in the manual.

When making changes, the original method will be overwritten. To keep the original method, make a copy of the method then rename.

Cutting Method Parameters

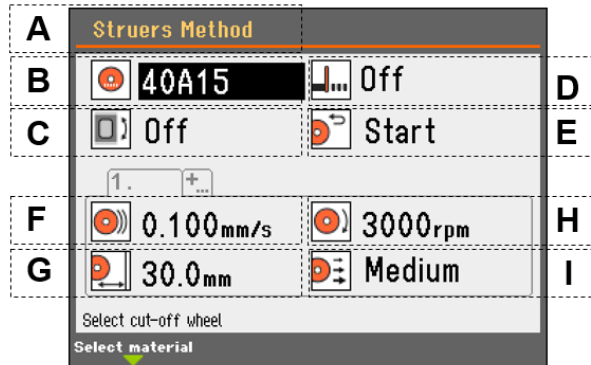

- |          |                      |          |                        |
|----------|----------------------|----------|------------------------|
| <b>A</b> | Cutting method       | <b>F</b> | Feed speed             |
| <b>B</b> | Cut-off wheel        | <b>G</b> | Cut length             |
| <b>C</b> | Rotation             | <b>H</b> | Cut-off wheel rotation |
| <b>D</b> | MultiCut             | <b>I</b> | Cutting force          |
| <b>E</b> | Cut-off wheel return |          |                        |







Cut-off wheel



- Select **Cut-off wheel** and push the knob.
- Select the cut-off wheel from the pop-up menus.

Alternatively,

- Press F1 for the *Material guide* menu.  
Select your Material and the diameter of **Cut-off wheel** in the pop-up menu and Accutom will suggest the suitable Struers cut-off wheel, and automatically retrieve the recommended rotational speed for that specific wheel.

	Parameter	Setting	Change Increment	Default
	<b>Wheel Speed</b>	300- 5000 rpm	50 rpm	Recommended setting for Cut-off wheel
	<b>Feed speed</b>	0.005 - 3.000 mm/sec (0.002-0.2 "/s).	0.005 mm/sec	0.100 mm/sec
	<b>Cut length</b>	1 - 110 mm	0.1 mm	30 mm
	<b>Rotation</b>	<b>OFF</b>		Off
		<b>Rotate:</b> Speed 1, 2 or 3		1
		<b>Oscillate:</b> Speed 1, 2 or 3 Angle 10-400 <sup>0</sup>	1 <sup>0</sup>	1 30 <sup>0</sup>

**MultiCut**  
(Accutom-100 only)



2 MultiCut modes are available:

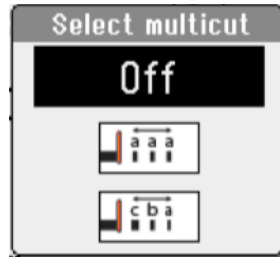

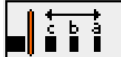
Icon	Mode	
	Off	Single cut.
	MultiCut 1	Cut up to 20 slices of equal thickness
	MultiCut 2	Cut up to 20 slices of varying thickness

For a detailed description of the [MultiCut](#) option and how it can be used, see the **Reference Guide** section of the Instruction Manual.

**Return position**



There are three available options for the position the cut-off wheel will return to after the cutting process is complete:

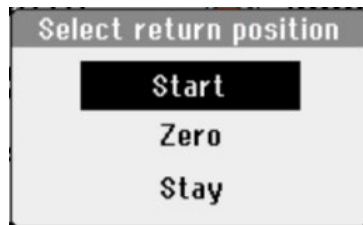

Start position:	Cut-off wheel returns to the start position.
Zero position:	Cut-off wheel returns to zero position.
Stay:	Cut-off wheel does not move after cutting.



**NOTE:**

When using Start or Zero return position, make sure that the Y-stop position is set correctly. If the workpiece is not cut through before the workpiece is retracted the cut-off wheel might be damaged.

**NOTE:**

Use the Stay function for Bakelite-bonded diamond or CBN cut-off wheels, as retraction might destroy the rim of the cut-off wheel.

Cutting Force Level



There are three available force levels:



Grinding Methods Parameters

For a detailed description on the [Cutting Method Parameters](#) and their use, see the **Reference Guide** section of the Instruction Manual.

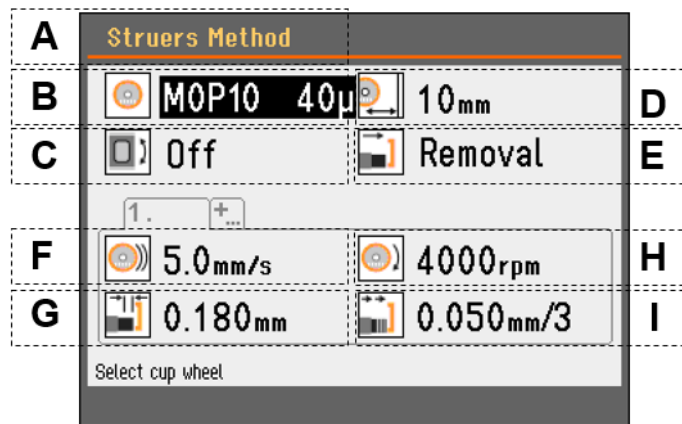







- |          |                 |          |                 |
|----------|-----------------|----------|-----------------|
| <b>A</b> | Grinding method | <b>F</b> | Feed speed      |
| <b>B</b> | Cup wheel       | <b>G</b> | Removal         |
| <b>C</b> | Rotation        | <b>H</b> | Cup wheel speed |
| <b>D</b> | Grinding length | <b>I</b> | Sweep parameter |
| <b>E</b> | Removal mode    |          |                 |

Cup wheel



- Select **Cup wheel** and Push the knob.
- Select the cup wheel from the pop-up menu.

	Parameter	Setting	Change Increment	Default
	<b>Wheel Speed</b>	300- 5000 rpm	50 rpm	Recommended setting for Cup wheel
	<b>Feed speed</b>	0.1 - 7.5 mm/sec	0.1 mm/sec	Recommended setting for Cup wheel
	<b>Rotation</b>	<b>OFF</b>		Off
		<b>Oscillate:</b> Speed 1, 2 or 3 Angle 10-400 <sup>o</sup>	1 <sup>o</sup>	1 30 <sup>o</sup>
	<b>Removal mode</b>	Removal or Relative		Removal
	<b>Stop position</b>	0.005 - 5.000 mm.	0.005 mm	0 mm
	<b>Sweep parameter</b>	<b>X-increment:</b> 0.005 – 1.000 mm	0.005 mm	0 mm
		<b>No. of sweeps:</b> 1-10	1	3
	<b>Grinding length</b>	1 - 110 mm	0.1 mm	0 mm

For a detailed description on the [Grinding Method Parameters](#) and their use, see the **Reference Guide** section of the Instruction Manual.

## Positioning Keys

The Positioning menu is displayed when the Positioning keys are pressed once.

- Press the hold-to-run button and the positioning keys to move the specimen holder arm / cut-off wheel with open guard.

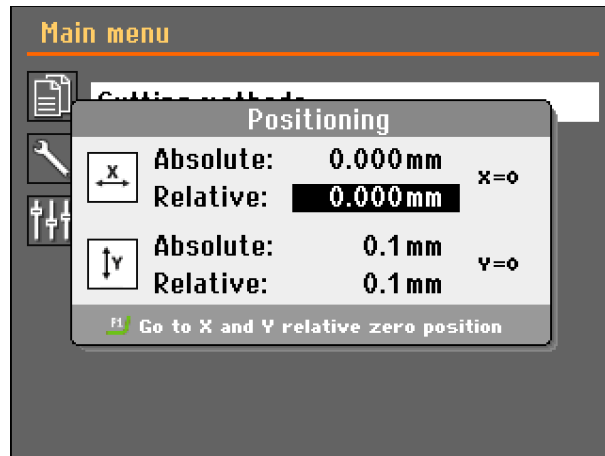

The positioning screen disappears after 5 s or when pressing ESC.

## Setting Relative Zero Position

When cutting or grinding identical workpieces / specimens, a relative zero position can be set:

- Move the workpiece / specimen to the desired X position, then press Enter.  
This will now be the X relative zero position.

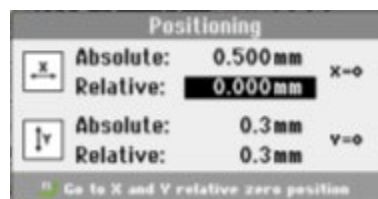

- Move the cut-off wheel / cup-wheel to the desired Y position, then press Enter.  
This will now be the Y relative zero position.

Moving to Relative Zero Position      To move the workpiece to X relative zero position:

- Close the guard
- Select **X = 0**, and press Enter.

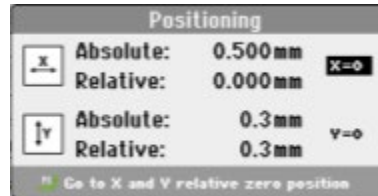

To move the cut-off wheel to Y relative zero position:

- Close the guard
- Select **Y = 0**, and press Enter.

To simultaneously move the workpiece and cut-off wheel to the X and the Y relative zero position:

- Close the guard.
- Press F1.

## Starting a Cutting Process

### Clamping the Workpiece

- Clamp the workpiece securely in the specimen holder. When cutting with rotation or oscillation, the workpiece and the specimen holder should be clamped so that they rotate evenly around the centre of the workpiece. This way the fastest cutting is obtained as the cut-off wheel will be cutting most of the time and the possibility of damaging the cut-off wheel is limited.



#### NOTE:

Ensure that the workpiece or specimen holder cannot come in contact with the cut-off wheel or the cooling fluid nozzles. Failure to do this may result in damage.

### Positioning the Workpiece

- Move the workpiece into the correct start position, close to the cut-off wheel, by using the hold-to-run button and the positioning keys.

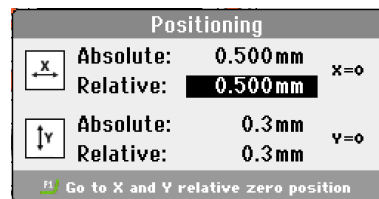

#### NOTE:

Check there are no obstacles in the cutting chamber before starting the cutting process.

#### NOTE:

Check the basket and the magnet for cutting debris before starting the cutting process; a blocked drain can result in water overflow and too little water in the tank to secure sufficient cooling.

- Close the guard of the machine.
- Press START .



#### NOTE:

Check that there is a steady flow of cooling fluid from the nozzles.

**The Cutting Process Screen**

The Cutting process screen shows information about the cutting process including:

- Cutting Parameters
- Motor Information
- Countdown timer

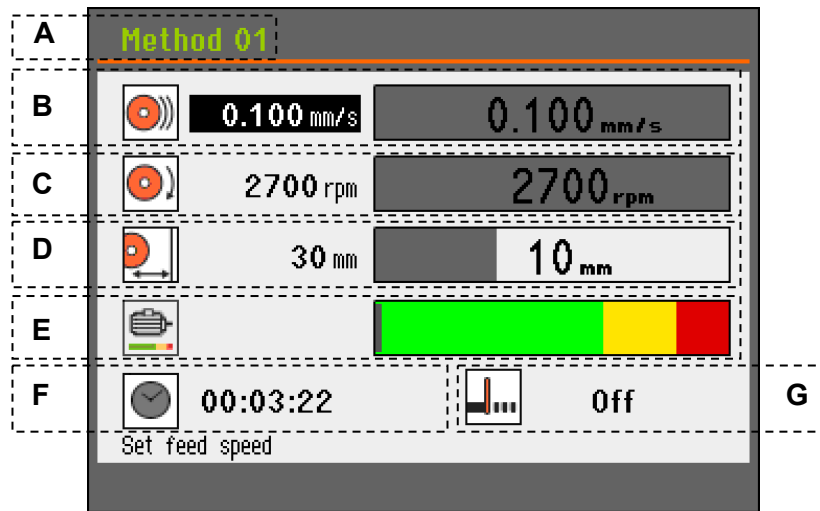

- |                              |                          |
|------------------------------|--------------------------|
| <b>A</b> Method              | <b>E</b> Motor load      |
| <b>B</b> Feed speed          | <b>F</b> Timer Countdown |
| <b>C</b> Cut-off wheel speed | <b>G</b> MultiCut        |
| <b>D</b> Length of cut       |                          |

Feed speed



Value selected

Actual Feed speed



Wheel speed



Value selected

Actual wheel speed



Length of cut



Value selected

Current length





Motor load



MultiCut

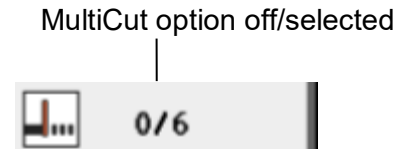

Timer Countdown

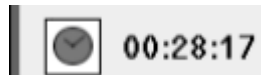

An estimate of time remaining for the cutting process.

*Manual Stop*

Accutom automatically stops cutting when the cutting process is complete, but can be stopped at any time during operation by pressing STOP ⏹.

*Re-starting cutting*

- Press START ⏻ to resume cutting.

*Changing Parameters During Cutting*

Feed speed, wheel speed and length of cut can be changed during the cutting process. E.g. if the load on the motor is too great, the feed speed can be reduced

- Select Feed speed.
- Press Enter ↵ and change the feed speed value.
- Press Enter ↵ again to confirm the change or Esc to cancel.

*Retracting the Workpiece*

If necessary, the cut-off wheel can be retracted from the workpiece after the cutting process has started.

- Press STOP ⏹ to interrupt the cutting process.
- Press the ▲ positioning key to move the wheel spindle away from the holder.
- Press START ⏻ to resume cutting.

The cut-off wheel will then start to move forward with the pre-set feed speed.

*OptiFeed*

If the motor becomes overloaded during cutting, the OptiFeed function will automatically reduce the feed speed. When the overload has been reduced, the feed speed will be increased to the pre-set level.

For similar workpieces to be cut afterwards, the feed speed should be reduced to the new value or below.

## Starting a Grinding Process

### Clamping the Specimen

- Clamp the specimen securely in the specimen holder. When grinding with oscillation, the specimen and the specimen holder should be clamped so that they rotate evenly around the centre of the specimen.



**NOTE:**

Ensure that the specimen holder cannot come in contact with the cup wheel or the cooling fluid nozzle. Failure to do this may result in damage.

### Positioning the Specimen

- Move the specimen into the correct start position, close to the cup wheel by using the hold-to-run button and the positioning keys.
  - Move the specimen in the X-direction until it slightly touches the cup wheel grinding surface.

**NOTE:** The wheel should still be able to be freely turned manually.
  - Move the cup wheel in the Y-direction until the specimen is just clear of the cup wheel grinding surface.



**NOTE:**

Check there are no obstacles in the chamber before starting the grinding process.

**NOTE:**

Check the basket and the magnet for cutting debris before starting the grinding process; a blocked drain can result in water overflow and too little water in the tank to secure a sufficient cooling.

- Close the guard of the machine.
- Press START .



**NOTE:**

Check that there is a steady flow of cooling fluid from the nozzle.

**The Grinding Process Screen**

The Grinding process screen shows information about the grinding process including:

- Grinding Parameters
- Motor Information
- Countdown timer

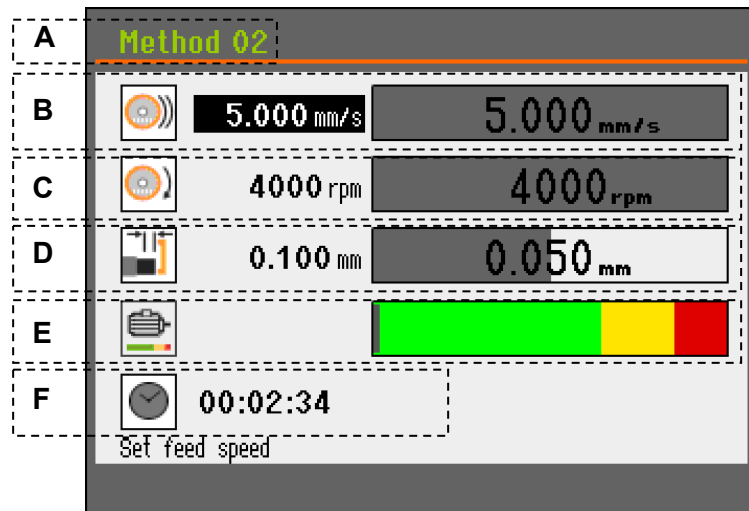

- |                          |                          |
|--------------------------|--------------------------|
| <b>A</b> Method          | <b>D</b> Removal         |
| <b>B</b> Feed speed      | <b>E</b> Motor load      |
| <b>C</b> Cup wheel speed | <b>F</b> Timer Countdown |

Feed speed



Value selected      Actual Feed speed



Wheel speed



Value selected      Actual wheel speed



Removal



Value selected      Current length



#### Motor load



#### Actual load on motor

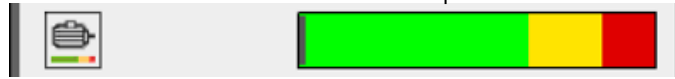

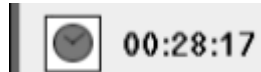

#### Timer Countdown



An estimate of time remaining for the grinding process.

#### Manual Stop

Accutom automatically stops grinding when the grinding process is complete, but can be stopped at any time during operation by pressing STOP .



- Press STOP  to manually interrupt the grinding process.

#### Re-starting grinding

- Press START  to resume grinding.



#### Changing Parameters During Grinding

Feed speed, wheel speed and removal can be changed during the process. E.g. if the load on the motor is too great, the feed speed can be reduced.

- Select Feed speed.
- Press Enter  and change the feed speed value.
- Press Enter  again to confirm the change or Esc to cancel.

#### Retracting the Specimen

If necessary, the cup wheel can be retracted from the specimen after the grinding process has started.

- Press STOP  to interrupt the grinding process.
- Press the  positioning key to move the wheel spindle away from the holder.
- Press START  to resume grinding.

The cup wheel will then start to move forward with the pre-set feed speed.

#### OptiFeed

If the motor becomes overloaded during grinding, the OptiFeed function will automatically reduce the feed speed. When the overload has been reduced, the feed speed will be increased to the pre-set level.

For similar specimens to be ground afterwards, the feed speed should be reduced to the new value or below.

### 3. Advanced Operation

#### Maintenance Menu

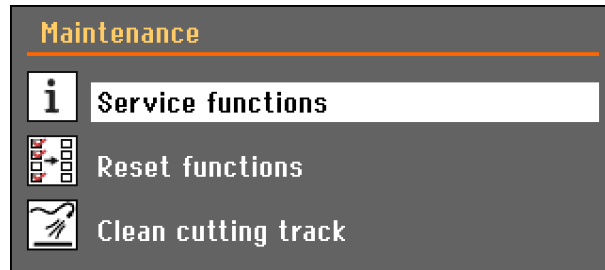

#### Service functions Menu

Information regarding the equipment, mainly to be used in connection with service.

#### Reset functions Menu

All cutting methods, grinding methods or the parameters in the *Configuration menu* can be reset to default values.

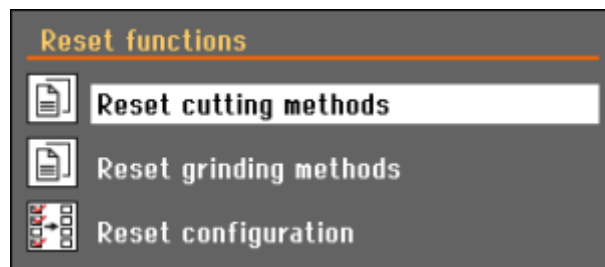

#### Clean cutting track

To move the cutting motor its full movement range backwards and forwards to keep the cutting track free from debris.

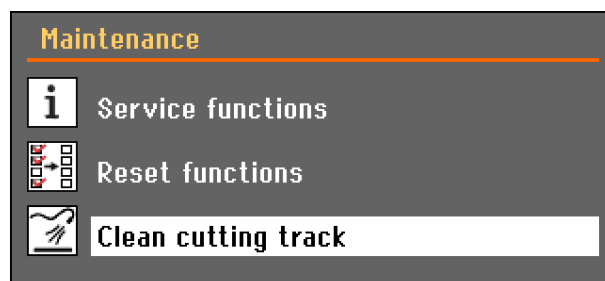

## Configuration Menu

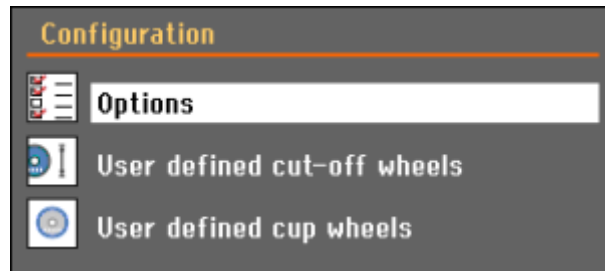

## Options Menu

The *Options* menu contains the parameters which apply to all methods.

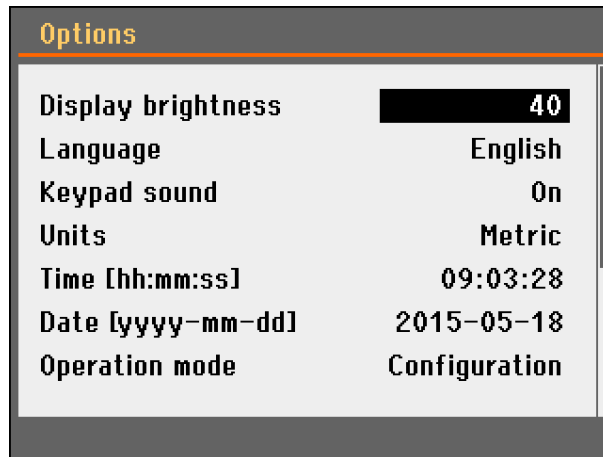

<b>Display brightness</b>	The brightness of the display can be adjusted to suit individual preferences. Can be set between 20-100
<b>Language</b>	Select the preferred language.
<b>Keypad sound</b>	Can be set to On or Off.
<b>Units</b>	The units displayed can be set to Metric (mm/s, mm) (default) or Imperial (mil/s, inch).
<b>Operation mode</b>	It is possible to select two different operation modes: Configuration or Production.
<b>Use Water</b>	Can be set to Yes or No. However, Struers recommends that the cooling fluid is set to Yes whilst cutting and grinding.
<b>Default Glass Thickness / Default Glue Thickness</b>	Accutom has a built-in calculator to help the operator calculate the amount of material to be ground. The default values are shown in the calculator screen.

- |                              |  |
|------------------------------|--|
| <b>Final sweeps</b>          | To achieve the best surface finish, the number of final sweeps can be set to a maximum of 10.  |
| <b>Align before grinding</b> | Can be set to Yes (default) or No. To achieve the best grinding precision, the Specimen holder arm is aligned by moving the X axis back and then forwards. |

### Changing Operation Mode

To change the operation mode, go to the *Configuration* menu and then the *Options* menu. Select **Operation mode** to access the *Operation mode* menu.

- Push knob to select Pass code.

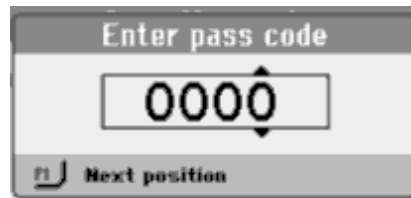

Use the F1 key and the knob to enter the current pass code (the default pass code is '2750'.):

- Use the F1 key to select digits.
- Turn knob to change the digits and press knob to enter the pass code.

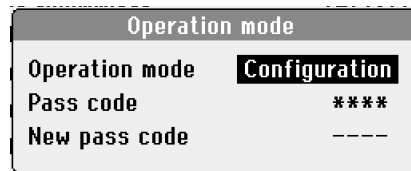

- Push knob to select **Configuration**.



- Select the desired operation mode and push knob to confirm.

- |                      |  |
|----------------------|--|
| <b>Configuration</b> | Full functionality.  |
| <b>Production</b>    | Access to START, STOP, <i>Stop position</i> and movement of cut-off wheel/ cup wheel, and to Display contrast and Keypad sound in the Options menu |

### New Pass Code



**NOTE:**

When a pass code is set, the operator has five attempts to enter the correct pass code after which Accutom will be locked. Re-start Accutom using the Main Switch then enter the correct Pass Code.

**NOTE:**

Remember to make a note of the new Pass code as settings can no longer be changed without the Pass code.

### Creating a User Defined Cut-off Wheel in the Database

- Select User defined cut-off wheel.

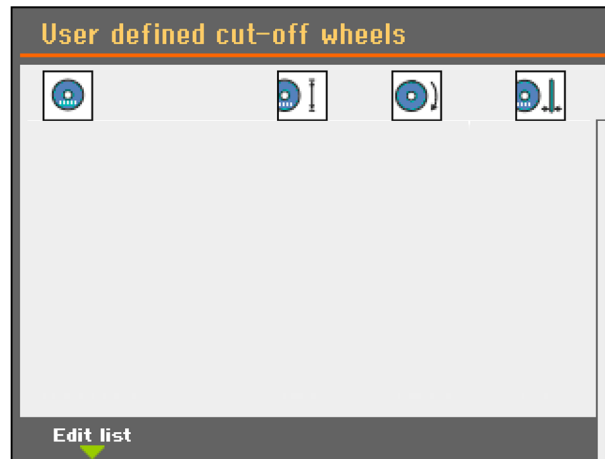

- Press F1 and select *New*.

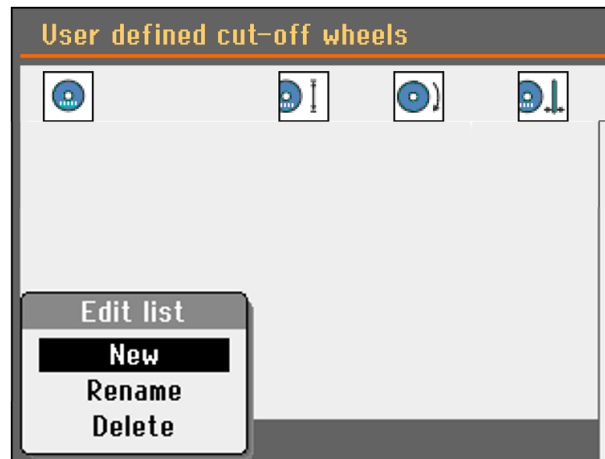

- Press F1 and select *Rename*.





- Enter a name for the wheel using the text editor. Use the knob and the Up Down keys to select then input the text desired. (Press F1 to toggle between upper and lower-case letters).

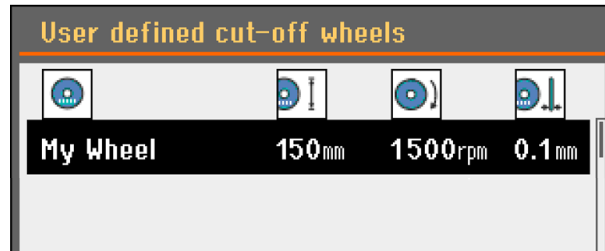

(Press Esc to abort the changes, and preserve the original setting, press Esc twice to return to the *Main menu*.)

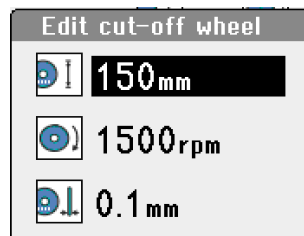

- Enter the parameters for the wheel.
- Press Esc twice to return to the *Main menu*.

### Creating a User Defined Cup Wheel in the Database

User defined Cup Wheels are entered into the database in the same way as a Cut-off Wheel.

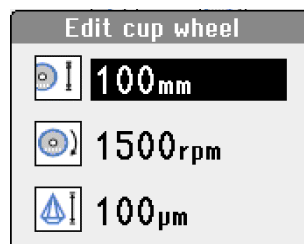

## Cutting Method Parameters

Depending on the specific requirements, the cutting parameters can be adjusted to achieve the required objectives. The following table can be used as a guide when selecting the cut-off wheel and cutting parameters according to the material to be cut.

<b>Recommended Cutting Parameters</b>				
<b>Material</b>	<b>Hardness [HV]</b>	<b>Force level</b>	<b>Feed speed [mm/s]</b>	<b>Wheel speed [rpm]</b>
Ceramics, minerals and crystals	> 800	LOW	0.005-0.15	5000
		LOW	0.005-0.20	4000
		HIGH	0.005-0.30	3200
		HIGH	0.005-0.30	2700
Sintered carbides and hard ceramics	> 800	MEDIUM	0.005-0.25	3200
		MEDIUM	0.005-0.25	2700
Extremely hard ferrous metals	> 500	MEDIUM	0.005-0.25	5000
Hard and very hard ferrous metals	350-800	MEDIUM	0.05-0.30	1000-5000
		MEDIUM	0.05-0.30	1000-5000
Hard and very hard ferrous metals with larger dimensions	350-800	MEDIUM	0.05-0.30	1000-5000
Soft and medium soft metals	30-350	MEDIUM	0.05-0.30	1000-5000
		MEDIUM	0.05-0.30	1000-5000
Soft and ductile non ferrous metals	70-400	MEDIUM	0.05-0.30	1000-5000
Plastics and very soft metals	< 100	MEDIUM	0.05-0.30	max. 1200

For additional help in developing methods, contact our team of application specialists on [application\\_dk@struers.dk](mailto:application_dk@struers.dk).

### Holder Rotation



*Rotation* is generally used when cutting round workpieces. By moving the surface of the cut, the feed speed and cut-off wheel speed can be increased without causing excess build-up of heat. The specimen will also have a more uniform scratch pattern on the surface and a better planeness. Additionally, the burr at the end of a cut will occur in the middle of the specimen. This will make it easier to remove the burr during the following preparation.



#### CAUTION

When working with machines with rotating parts, care must be taken that clothes or hair cannot be caught by the rotating parts.

*Oscillation* is useful when cutting very hard materials as it will reduce the build-up of thermal energy. *Oscillation* is also used for fragile materials as there is a better distribution of the force used to cut through the workpiece.

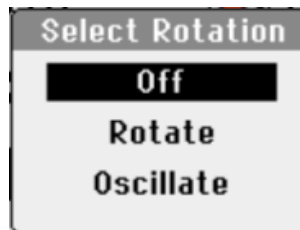

- Off:** The workpiece does not rotate.  
**Rotation:** The workpiece rotates around its centre.

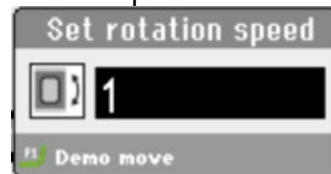

- Oscillate:** The workpiece oscillates around its centre. Rotation is forwards, then back to the original position.



For a demonstration of the movement:

- Press F1 to start Rotation/ Oscillation and check for correct alignment.
- Press F1 again to stop the movement.

### MultiCut Equal size



The first MultiCut option permits the cutting of several slices of equal width.

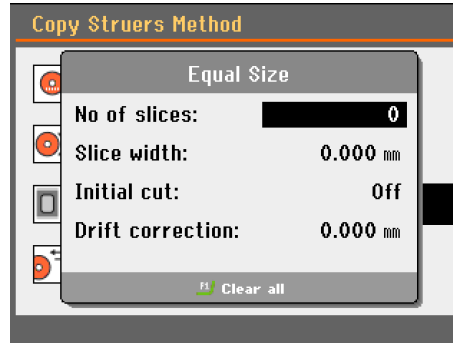

- |                               |   |
|-------------------------------|---|
| <b>No. of slices:</b>         | This parameter sets the number of slices that will be cut.  |
| <b>Slice width</b>            | This parameter sets the width of the slices that will be cut.   |
| <b>Initial cut</b>            | Select this parameter if you need to make an initial cut, before you start cutting the slices that you need. This cuts a scrap of material, which you will not use. For example, if the workpiece has an uneven edge.   |
| <b>Drift Correction Value</b> | The nominal thickness values for all Struers cut-off wheels are already saved within the wheel definitions. Whenever a cut-off wheel is selected, that particular wheel-thickness will automatically be used. For user defined wheels though, the thickness must be entered manually when configuring the wheels in the configuration menu. |

Accutom automatically compensates for the thickness of the cut-off wheel when MultiCut is used. However, due to differences in feed speed and wheel speed between different methods where the same wheel is used, additional compensation might be necessary:

- After cutting a few test slices, the obtained thickness is measured, and the deviation from the pre-set thickness must be entered as drift correction value.

### MultiCut Different Sizes



The second MultiCut option permits the cutting of several slices of different widths.

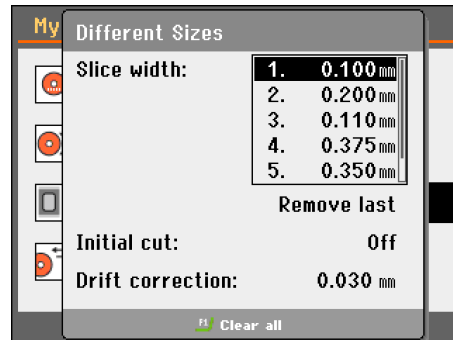

#### Slice width

This parameter sets the width of the slice that will be cut.

#### Initial cut

Select this parameter if you need to make an initial cut, before you start cutting the specimens that you need. This cuts a scrap of material, which you will not use. For example, if the workpiece has an uneven edge.

#### Drift Correction Value

The nominal thickness values for all Struers cut-off wheels are already saved within the wheel definitions. Whenever a cut-off wheel is selected, that particular wheel-thickness will automatically be used. For user defined wheels though, the thickness must be entered manually when configuring the wheels in the configuration menu.

Accutom automatically compensates for the thickness of the cut-off wheel when MultiCut is used. However, due to differences in feed speed and wheel speed between different methods where the same wheel is used, additional compensation might be necessary:

- After cutting a few test slices, the obtained thickness is measured, and the deviation from the pre-set thickness must be entered as drift correction value.

*Cutting Force Level:*



During cutting, Accutom continuously measures the load on the cutting motor. The factors that determine the load, are the shape and properties of the workpiece.

Whenever the maximum allowed motor load is reached, the OptiFeed function automatically reduces the Feed speed.

As soon as the load drops below the set limit, the speed will be increased to the original setting.

Force level	OptiFeed activates at a Motor load of:
Low:	45 %
Medium:	60 %
High:	100 %

*Optimising the Cutting Results*

The following table has some guidelines on how to achieve some common objectives:

Objective	Recommendation
<b>Better cutting</b>	Clamp the workpiece securely using Struers' range of Specimen Holders.
<b>Better surface quality</b>	Use lowest recommended feed speed, highest recommended wheel speed and no specimen holder rotation.
<b>Lower wheel wear</b>	Use the lowest recommended feed speed, highest recommended wheel speed and no specimen holder rotation. This is especially important when using resin bonded wheels and all abrasive cut-off wheels.
<b>Problems with abrasive cut-off wheels?</b>	Abrasive cut-off wheels should not be used outside their recommended feed speed range. At lower than recommended feed speeds they will produce irregularly cut surfaces. At higher feed speeds excessive wheel wear will occur, along with increased risk of wheel breakage.
<b>Flatter specimens</b>	Use primarily low feed speeds, highest recommended wheel speed, largest possible flanges and no specimen holder rotation. The initial cut is especially critical. If the initial feed speed is too high the wheel will bend and start cutting at an angle. Such a cut will never end up flat.
<b>Better parallelism</b>	Use the lowest recommended feed speed.

Objective	Recommendation
<b>Faster cutting</b>	Orientate the workpiece so that the wheel will cut the smallest possible cross-section and then use maximum recommended feed speed.
<b>Cutting composite materials</b>	Use the lowest recommended force level for the materials in the composite. See <a href="#">Cutting Method Parameters</a> .

### Grinding Method Parameters

Use the following table as a guide to select the grinding parameters according to the specimen material.

Grinding Method Parameters							
Material	Hardness [HV]	Wheel	Precision	Feed speed [mm/s]	X-increment	No. of final sweeps	Wheel speed [rpm]
Ceramics, minerals and crystals	> 800	M0PXX	High	0.1-0.2	5-10 µm	10	4000 (100 mm dia) 2650 (150 mm dia)
			Medium	0.2-4.0	10-20 µm	5	
			Low	4.0-7.5	20-30 µm	2	
Sintered carbides, hard ceramics and hard composites	> 600	B0PXX	High	0.1-0.3	5-10 µm	10	4000
			Medium	0.3-0.5	10-20 µm	5	
			Low	0.5-1.0	20-30 µm	2	
Ductile		10P13					

For additional help in developing methods, contact our team of application specialists on [application\\_dk@struers.dk](mailto:application_dk@struers.dk).

### Holder Rotation



*Oscillation* is used when a more uniform scratch pattern on the surface and optimal planeness is required. *Oscillation* is also used for fragile materials as there is a better distribution of the force used during grinding.

- Off:** The holder does not rotate.  
**Oscillate:** The holder oscillates around its centre.

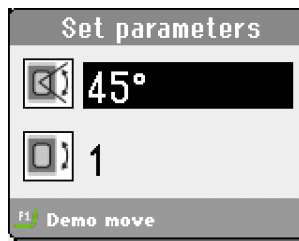

For a demonstration of the movement:

- Press F1 to start Oscillation and check for correct alignment.
- Press F1 again to stop the movement.

### Positioning mode

- Removal** To remove a specified amount of material.  
**Relative** To remove material until a set relative position is reached.

Removal:

To remove a precise amount of material:

E.g. a component is exactly 0.125 mm underneath the specimen surface:

- Move the specimen as close to the cup wheel as possible, without touching each other using the hold-to-run button and the ► positioning key.
- While holding the hold-to-run button and press the ► positioning key to move the specimen slowly against the cup wheel just until there is just contact between specimen and wheel.
- Set the relative X-position to zero.
- After having defined the amount of material to be removed, move the specimen slightly away from the cup wheel, in the Y-direction.
- Press START ◊, and after completing the grinding process Accutom will stop precisely at the pre-defined depth.

Relative:

E.g. a component is exactly 0.125 mm underneath the specimen surface:

- Move the specimen as close to the cup wheel as possible, without touching each other using the hold-to-run button and the ► positioning key.
- While holding the hold-to-run button and press ► positioning key to move the specimen slowly against the cup wheel just until there is just contact between specimen and wheel.
- Set the relative X-position to zero.



Press ESC then set the stop position to 0.125 mm.

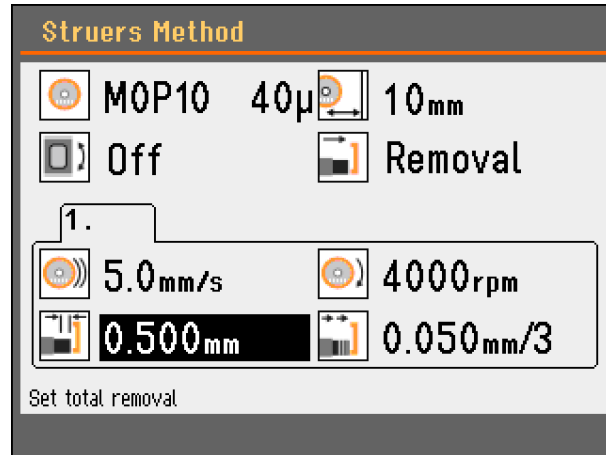

- After having defined the amount of material to be removed, move the specimen slightly away from the cup wheel, in the Y-direction.
- Press START  $\diamond$ , and after completing the grinding process Accutom will stop precisely at the pre-defined position.

## Grinding Thin Sections *Preparing the Glass Slides*

This method is mainly used for mineralogy.

- Grind the ceramic plate of the vacuum holder so that it is plane, parallel to the cup wheel.
- Set the relative X-position to zero.
- Change the removal mode to Relative.
- Enter the desired final thickness of the glass slide you want to grind by setting the Stop position to the required value.  
E.g. for slides which are exactly 1.950 mm thick, set the relative stop position to -1.950 mm.
- Move the holder away from the cup wheel to allow the glass slide to be inserted.
- Place the glass slide on the vacuum holder.
- Move the holder close to the cup wheel.
- Move the cup wheel slightly away from the vacuum holder.
- Press START  $\diamond$  to grind the glass down to the pre-set thickness.

Additional slides of the same thickness can now be prepared by mounting in the holder, moving the holder close to the cup wheel, then starting the grinding process.

## Grinding the Specimen

- Glue the specimen on a pre-ground glass slide.
- Measure the total thickness of the glass and the specimen.
- Insert the glass slide with specimen in the holder.
- Press F1 to view the Calculator and input the values. In the example below, to obtain a specimen which is 0.500 mm thick, 0.180 mm of material needs to be removed.

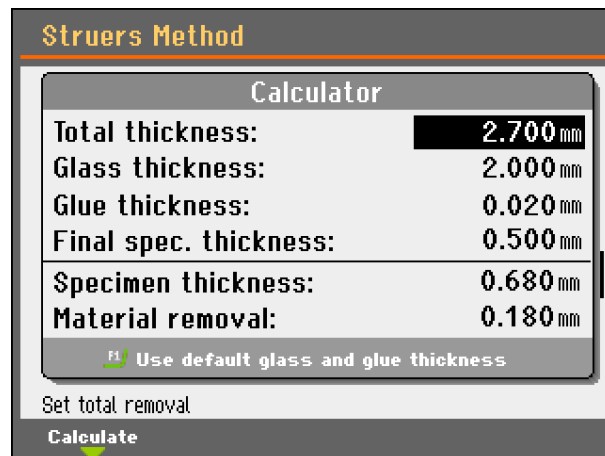

- With positioning mode set to Removal, input the amount of material to be removed.

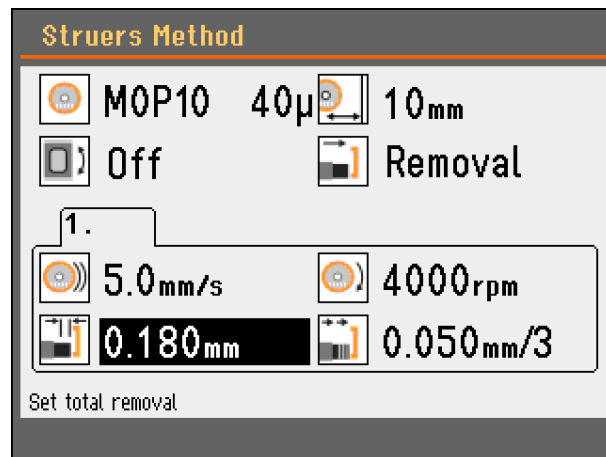

- Reposition the specimen close to the cup wheel.
- Press START  $\diamond$  to grind the specimen down to the correct thickness.



**HINT:**

Alternatively, zero the X position after the last slide has been ground.

With positioning mode set to Relative mode, input the stop position as the thickness of the specimen – 0.500 mm.



**HINT:**

To avoid over grinding, grinding to the required thickness is performed in steps.

E.g. if 180 µm of material is to be removed, the first step will be to remove 150 µm of material. After the specimen is inspected and re-measured, the next step will be set to remove 5-10 µm of material.

This process will be repeated until the correct specimen thickness is achieved.

## Grinding length

The movement of the cup wheel in the Y direction.

## 4. Maintenance

Proper maintenance is required to achieve the maximum uptime and operating lifetime of the machine. Maintenance is also important in ensuring your machine's continued safe operation. The maintenance procedures described in this section must be carried out by skilled or instructed persons.

### General Cleaning

To ensure a longer lifetime for your Accutom Struers strongly recommends daily cleaning of the cutting chamber. Clean the cutting chamber thoroughly if the Accutom is not to be used for a longer period of time.

### Daily Inspection

Accutom-100 must be checked before use. Do not use the machine until any damage is repaired.

### Checking the Guard

- Visually inspect the guard for signs of wear or damage (e.g. dents, cracks, damage to edge sealing).

Please refer to the section on [Replacing the Guard](#) if the guard is damaged.

The guard screen should be **replaced immediately** if it has been weakened by collision with projectile objects or if there are visible signs of deterioration or damage.

### Checking the Safety Lock

It is very important that the interlock tongue is checked regularly for damage and perfect fitting.

- Check the interlock tongue for correct function. It must slide unobstructed into the locking mechanism.

**Daily Maintenance**  
Machine

- Clean all accessible surfaces with a soft, damp cloth.



**NOTE:**

Do not use a dry cloth as the surfaces are not scratch resistant. Grease and oil can be removed with ethanol or isopropanol.

**NOTE:**

Never use acetone, benzol or similar solvents.

- Clean the chamber with the flushing hose.



**CAUTION**

Read the Safety Data Sheet for the additive for cooling fluid before use.

Avoid skin contact with the additive for cooling fluid.

Use of gloves and safety goggles is recommended. Cooling fluid may contain swarf (cutting /grinding debris or other particles).

**Do not** start the flushing until the flushing hose is pointing into the cutting chamber.

- If necessary, clean the tray, drain basket and the magnet in the tank.
- Clean the specimen holder arm and the clamps for the dovetail feed.
- Clean the flanges.



**HINT:**

Leave the guard open when the machine is not in use to let the cutting chamber dry completely.

## Weekly

Clean Accutom regularly to avoid damaging effects to the machine and the specimens from abrasive grains or metal particles.

- Clean painted surfaces and the control panel with a soft damp cloth and common household detergents.  
For heavy duty cleaning, use Struers Cleaner (Cat. No. 49900027).
- Clean the guard with a soft damp cloth and a common household anti-static window cleaning agent.
- Do not use harsh or abrasive cleaning agents.



**NOTE:**

Ensure that no detergent or cleaning agent residue is flushed into the cooling unit tank; excess foaming will occur.

## Cleaning the Cutting Chamber

- Remove the specimen holder.
  - Clean the specimen holder: movable parts, dovetail feeds and screws. Lubricate with oil (e.g. a universal household oil).
  - Store the specimen holder in a dry place.
- Clean the chamber, the tray and guard thoroughly.
- Check the drain basket and the magnet.  
A blocked drain can result in water overflow and too little water in the tank to secure sufficient cooling.  
This could lead to damage to the workpiece or the cut-off wheel / cup wheel.
- Oil the wheel spindle/bushing where the wheel is mounted (e.g. a universal household oil).
- Clean the cutting tracks.
  - Remove all obstacles from the cutting chamber and close the guard.
  - Select *Clear cutting tracks* from the *Maintenance menu*. Press **Enter** to continue.

### Checking the Cooling Fluid Tank

- Check the level of the cooling fluid after 8 hours of use or at least every week. Refill if necessary.  
Replace the cooling fluid if it appears dirty (build up of cutting debris).  
Remember to add Struers additive, Cooli Additive.  
To check the concentration of additive, use a refractometer.  
Please see the instructions for use on the label.  
It is recommended to change the cooling fluid at least once a month to prevent the growth of microorganisms.



#### CAUTION

Read the Safety Data Sheet for the additive for cooling fluid before use.

Avoid skin contact with the additive for cooling fluid.

Use of gloves and safety goggles is recommended. Cooling fluid may contain swarf (cutting /grinding debris or other particles).

### Cooling Fluid Nozzles

- Should the cooling fluid nozzles become blocked, clear the blockage with a thin piece of wire (e.g. a paper clip).  
The screw can be removed from the tip of the right nozzle to aid cleaning.

### Tube for Water-free Cooling Fluid

When working with Water-free Cutting Fluid, the standard tube mounted in the cooling fluid pump will only last for a few days. A special tube, which is more resistant to the components of the Water-free Cutting Fluid, is available as a Spare Part. (Cat. No. 05996921)  
See [Changing Cooling Pump Tubes](#) for details on changing the pump tube.

Once mounted, the Tube for Water-free Cooling Fluid must be checked for wear on a regular basis.

The frequency for changing the tube will vary according to specific conditions. It is recommended to visually check the Tube for Water-free Cooling Fluid for wear after every 5 hours of use.

## Cleaning the Cooling Fluid Tank

Replace the cooling fluid in the Cooling fluid tank at least once a month.

- Slide the cooling fluid tank out gently.



- Remove the screw cap and pour out the used cooling fluid into a drain approved for waste chemicals.
- Rinse the tank with clean water, periodically shaking the tank to release any debris that has accumulated on the bottom of the tank. Repeat the rinsing process until the tank is clean.
- Replace the screw cap.
- Slide the tank back into position.
- Fill the tank by pouring a 4% solution of Struers additive, Cooli Additive:  
**190ml Cooli Additive and 4.5 l water**  
through the hole in the base of the chamber For water-sensitive materials, use Struers Water-Free Cooling Fluid.



**NOTE:**

Take care not to overfill the tank!

**NOTE:**

Flush the Recirculation cooling system with clean water if Accutom is not to be used over longer periods of time. This will prevent any dried residue of cutting material from damaging the inside of the pump.



**CAUTION**

Read the Safety Data Sheet for the additive for cooling fluid before use.

Avoid skin contact with the additive for cooling fluid.

Use of gloves and safety goggles is recommended. Cooling fluid may contain swarf (cutting /grinding debris or other particles).

**Do not** start the flushing until the flushing hose is pointing into the cutting chamber.



### Yearly Inspection of Guard

The guard consists of a metal frame and a copolyester material that protects the operator. In the event of damage, the guard will be weakened and offer less protection.

- Visually inspect the guard for signs of wear or damage (e.g. dents, cracks).



**NOTE:**

Carry out inspection at more regular intervals if Accutom is used for more than one 7-hour shift a day.

### Replacing the Guard

The guard should be **replaced immediately** if it has been weakened by collision with projectile objects or if there are visible signs of deterioration or damage.



**WARNING**

To ensure its intended safety, the guard must be replaced every 3 years<sup>3</sup>. A label on the guard indicates when it is due to be replaced.



### Testing Safety Devices

The guard has a safety switch system to prevent the cut-off wheel/cup wheel motor from starting while the guard is open. Furthermore, a locking mechanism prevents the operator from opening the guard until the motor stops spinning.



**NOTE:**

Testing should always be performed by a qualified technician (electromechanical, electronic, mechanic, pneumatic etc.)

### Emergency Stop

- Start a cutting process.
- Activate Emergency stop.  
If the process does not stop, press STOP ⏹ and contact Struers Service.
- Activate Emergency stop.
- Press START ⏻.  
If the machine starts, press STOP ⏹ and contact Struers Service.

<sup>3</sup> Replacement of the guard is required to remain compliant with the safety requirements in the European standard EN 16089.

### Safety lock

- Start a process.
- Try to open the guard – do NOT use force.  
If it opens, press STOP Ⓢ and contact Struers Service.
  
- Open the guard.
- Press START Ⓢ.  
If the process starts, press STOP Ⓢ and contact Struers Service.
  
- Start a process.
- Press STOP Ⓢ.  
If it is possible to open the guard while the cut-off wheel/cup wheel still rotates, contact Struers Service.

### Hold-to-run Button

- Open the guard.
- Without pressing the hold-to-run button, use the keys to move the cutting arm.  
If the cutting arm moves, contact Struers Service.
  
- Open the guard.
- Without pressing the hold-to-run button, use the keys to move the cut-off wheel/cup wheel.  
If it moves, contact Struers Service.
  
- Open the guard.
- Press FLUSH Ⓢ.  
If cooling fluid starts to run, press FLUSH Ⓢ or STOP Ⓢ and contact Struers Service.



#### WARNING

Do NOT use the machine with defective Safety Devices.  
Contact Struers Service.

### Spare Parts

Please see [Spare Parts and Diagrams](#) in the Reference Guide section of the Instruction Manual.

## Maintenance of Cut-off Wheels and Cup Wheels



### **HINT:**

For detailed maintenance instructions for the Cut-off Wheels and Cup Wheels, please see the Instruction Manual supplied with the wheels.

### *Abrasive Cut-off Wheels*

These cut-off wheels are sensitive to humidity. Therefore, do not mix new, dry cut-off wheels with used humid ones. Store the cut-off wheels in a dry place, horizontally on a plane support.

### *Diamond and CBN Cut-off Wheels*

The precision of diamond and CBN cut-off wheels (and thus the cut) depends on how carefully the following instructions are observed:

- Never expose the cut-off wheel to a heavy mechanical load, or heat.
- Store the cut-off wheel in a dry place, horizontally on a plane support, preferably under light pressure.
- A clean and dry cut-off wheel does not corrode. Therefore, clean and dry the cut-off wheel before storing. If possible, use ordinary detergents for the cleaning.
- Regular dressing of the cut-off wheel is also part of the general maintenance.

### *Dressing Diamond and CBN Cut-off Wheels*

A newly dressed cut-off wheel will give an optimum cut. A badly maintained and dressed cut-off wheel demands a higher cutting pressure that will result in more frictional heat. The wheel may also bend and cause a skew cut. A combination of both factors may result in damage to the cut-off wheel.

To dress the cut-off wheel, use the aluminium oxide dressing stick supplied with the cut-off wheel.

- Mount the dressing stick like a workpiece.
- Cut through the dressing stick using a moderate feed speed.
- Repeat the treatment if the cut-off wheel does not cut satisfactorily.



**NOTE:**

Do not perform more dressing than necessary as this will cause needless wear on the wheel.

**NOTE:**

A badly dressed cut-off wheel is the most frequent reason for damage to the wheel.

### *Testing Cut-off Wheels*

Cut-off wheels must be inspected before use.

To test an abrasive cut-off wheel for damage:

- Visually inspect the surface for cracks and chips.
- Mount the cut-off wheel, close the guard and let it rotate with full speed.
- If there is no visible damage and it did not break during the high-speed test, it passed the test. If the cut-off wheel shows cracks, it is unsafe to use.

To test a Diamond/CBN cut-off wheel, perform a ring test:

- Let the cut-off wheel hang over your index finger.
- With a pencil (not metal), gently tap the cut-off wheel around the edge.
- The wheel passes the test if it gives a clear metallic tone when tapped. If the wheel sounds dull or muted, it is cracked. Do not use it.

### Changing Cooling Pump Tubes

To exchange the tube:

- Remove the four screws on the protection plate on the rear of the machine.

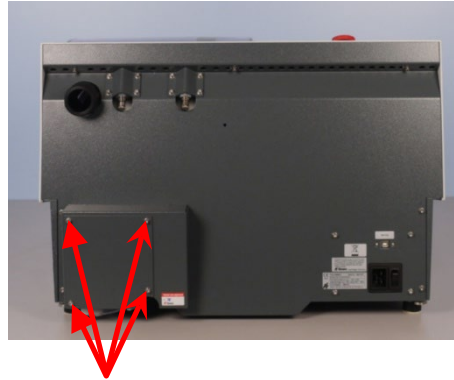

- Remove the three screws on the cover on the cooling pump.

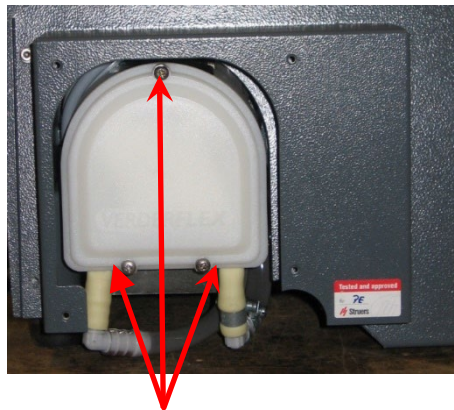

- Remove the tube from the pump axle.

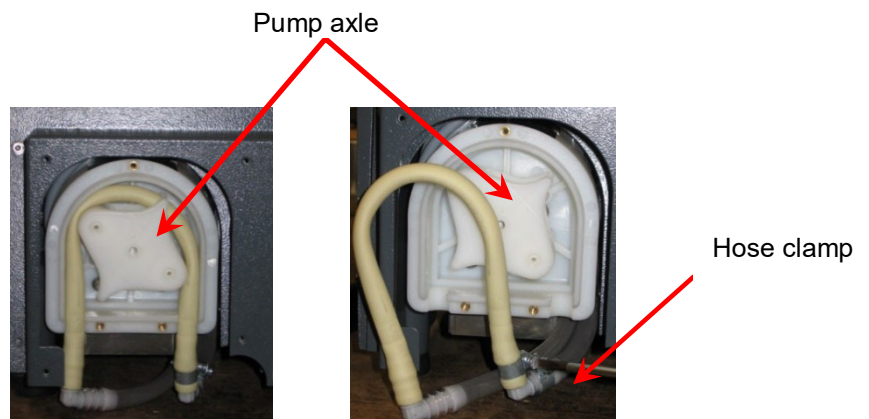

- Loosen the hose clamp and carefully remove the tube ends from the connectors.
- Attach the new tube to the connectors and tighten the hose clamp (the hose clamp should be on the end of the tube that directs water into the cutting chamber, as this will have the greatest pressure – see picture).

- Lubricate the tube along its length with the silicon grease enclosed (this will help the rollers in the pump to turn smoothly).
- Press the tube into position around the pump axle. Mount the tube correctly in the pump:

**Correct:**

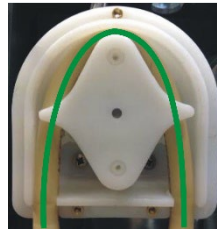

**Incorrect:**

Too loose

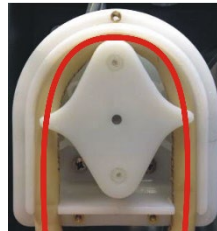

Excess volume between the rollers will press "waves" of fluid which will stretch the tube; lifetime of the tube will be reduced.

Too tight

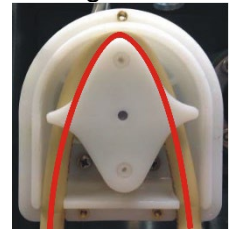

The tube is stretched; lifetime of the tube will be reduced.

- Replace the pump cover and the protection plate.

## Spare Parts

For further information, or to check the availability of replacement parts, please contact your local Struers Service department. Contact information is available on [Struers.com](http://Struers.com).

## 5. Cautionary Statements



### WARNING

To ensure its intended safety, the guard must be replaced every 3 years<sup>4</sup>. A label on the guard indicates when it is due to be replaced.



### WARNING

Do NOT use the machine with defective Safety Devices.  
Contact Struers Service.



### WARNING

In case of fire, alert bystanders, the fire brigade and cut power.  
Use a powder fire extinguisher. Do not use water.



### WARNING

Safety critical components are to be replaced after a maximum lifetime of 20 years.  
The guard must be replaced after a lifetime of 3 years.

Contact Struers Service for information.



### ELECTRICAL HAZARD

Switch the power off when installing electrical equipment.  
The machine must be earthed (grounded).  
Check that the mains voltage corresponds to the voltage stated on the type plate on the side of the machine.  
Incorrect voltage may result in damage to the electrical circuit.



### CRUSHING HAZARD

Take care not to trap fingers when handling the machine.  
Wear safety shoes when handling heavy machinery.



### CAUTION

Read the Safety Data Sheet for the additive for cooling fluid before use.  
Avoid skin contact with the additive for cooling fluid.  
Use of gloves and safety goggles is recommended.

<sup>4</sup> Replacement of the guard is required to remain compliant with the safety requirements in the European standard EN 16089.



**CAUTION**

Avoid skin contact with the additive for cooling fluid. Always wear gloves and goggles.  
**Do not** start the flushing until the flushing hose is pointing into the cutting chamber.



**CAUTION**

Prolonged exposure to loud noises may cause permanent damage to a person's hearing.  
Use hearing protection if exposure to noise exceeds levels set by local regulations.



**CAUTION**

Mind the protruding safety catch when the guard is raised.



**CAUTION**

Read the Safety Data Sheet for the additive for cooling fluid before use.  
Avoid skin contact with the additive for cooling fluid.  
Use of gloves and safety goggles is recommended. Cooling fluid may contain swarf (cutting /grinding debris or other particles).  
**Do not** start the flushing until the flushing hose is pointing into the cutting chamber.



**CAUTION**

Read the Safety Data Sheet for the additive for cooling fluid before use.  
Avoid skin contact with the additive for cooling fluid.  
Use of gloves and safety goggles is recommended. Cooling fluid may contain swarf (cutting /grinding debris or other particles).



**CAUTION**

When working with machines with rotating parts, care must be taken that clothes or hair cannot be caught by the rotating parts.



## 6. Transport and Storage



**NOTE:**

Package the machine securely before transportation. Insufficient packaging could cause damage to the machine and will void the warranty. Contact Struers Service for advice. Struers recommends that all original packaging and fittings are kept for future use.

Follow these steps:

- Clean the machine.
- Disconnect the power supply, and exhaust system.
- Slide the cooling fluid tank out gently.
- Empty the cooling tank and rinse with clean water.
- Position the lifting straps<sup>5</sup> on Accutom.

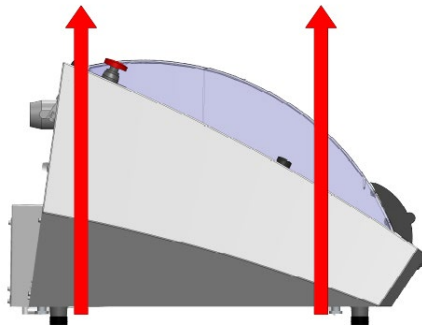

- Move it to its new position.

If the machine is bound for long-time storage or shipping, follow these additional steps:

- Place the machine on the blocks on the original pallet.
- Secure the machine using the original transport brackets.
- Build the crate.
- Place the accessories and other loose items in the crate.
- To keep the machine dry, plastic-wrap the machine and place a bag of desiccant (silica gel) with the machine.

At the new location, check that the facilities required are in place.

- See the Pre-Installation Checklist.

<sup>5</sup> The crane and the straps must be approved for at least twice the weight of the load.

## 7. Disposal

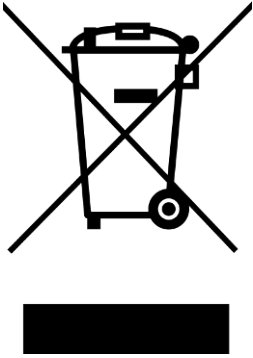

Equipment marked with a WEEE symbol  contains electrical and electronic components and must not be disposed of as general waste.

Please contact your local authorities for information on the correct method of disposal in accordance with national legislation.

**NOTE:**

Swarf must be disposed of according to the current safety regulations for handling and disposal of swarf/ additive for cooling fluid.

**NOTE:**

The cooling fluid will contain additive and cutting/grinding swarf and may **NOT** be disposed of into a main drain. Cooling fluid must be disposed of in compliance with local safety regulations.

**Please note:**

Depending on which metals are being cut/ground, it is possible that the combination of the metallic swarf (cutting debris) from metals with a large difference in electro positivity (a large distance apart in the electrochemical series), could result in exothermic reactions when 'favourable' conditions are present.

Therefore, it is always good practice to bear in mind which metals are being cut and the amount of swarf produced.

*Examples:*

The following are examples of combinations which could result in exothermic reactions if a large amount of swarf is produced during cutting/ grinding on the same machine, and when favourable conditions are present:

*Aluminium and Copper*

*Zinc and Copper*



**WARNING**

In case of fire, alert bystanders, the fire brigade and cut power. Use a powder fire extinguisher. Do not use water.

# Reference Guide

Table of Contents	Page
<b>1. Struers Knowledge</b> .....	82
<b>2. Accessories and Consumables</b>	
Accessories .....	83
Consumables .....	83
Cut-off Wheels .....	83
<i>Cup Wheels</i> .....	83
Other consumables.....	84
<b>3. Trouble-Shooting</b> .....	85
<b>4. Service</b> .....	92
Service Check .....	93
<b>5. Spare Parts and Diagrams</b>	
Safety Related Parts of the Control System (SRP/CS).....	94
Spare Parts List.....	96
Diagrams .....	97
16173051 Accutom, Block diagram .....	98
16173101 Accutom, Circuit diagram .....	99
16171004 Accutom, Air diagram .....	103
16171003 Accutom, Water Diagram .....	104
<b>6. Legal and Regulatory</b>	
FCC Note.....	105
EN ISO 13849-1:2015.....	105
<b>7. Technical Data</b> .....	106

## 1. Struers Knowledge

Materialographic sectioning is where most microstructure analysis begins. A good understanding of the abrasive cutting process can help to select suitable clamping and cutting methods and thereby ensure the high-quality cut. Minimizing cutting artefacts will help the remaining materialographic process and act as a good base for efficient and high-quality preparation.



**HINT:**

For further information, see the section on [Cutting](#) on the Struers website.

For additional help, contact our team of application specialists on [application\\_dk@struers.dk](mailto:application_dk@struers.dk).

## 2. Accessories and Consumables

### Accessories

Please refer to the [Accutom Brochure](#) for details of the range available.

### Consumables

*The use of Struers consumables is recommended. Other products (e.g. coolants) may contain aggressive solvents, which dissolve e.g. rubber seals. The warranty may not cover damaged machine parts (e.g. seals and tubes), where the damage can be directly related to the use of non-Struers consumables.*

### Cut-off Wheels

Please refer to the Selection Guide in the [Struers Consumables Catalogue](#).

### Cup Wheels



Please refer to the list of Cup Wheels in the Struers [Consumables Catalogue](#).

Other consumables

Specification	No.
<p><i>Cooli Additive</i> Additive for recirculation water for cutting and grinding. Additive to improve cutting/grinding and cooling properties and protect the machine from corrosion. Recommended concentration: 4%</p> <p>1 l 4 l</p>	<p>49900074 49900073</p>
<p><i>Cooli Additive Plus</i> High performance cutting additive for recirculation water. Additive to improve cutting and cooling properties and protect the machine from corrosion. Recommended concentration: 4%</p> <p>1 l 4 l</p>	<p>49900071 49900072</p>
<p><i>Corrozip-Cu</i> Additive for Cooling Fluid. To protect the machine from corrosion and to improve cutting and cooling qualities. For Recirculation Cooling Unit. For machines which mainly cut copper and copper alloys.</p> <p>1 l 5 l</p>	<p>49900068 49900069</p>
<p><i>Water-free Cutting Fluid</i> Water free Cutting Fluid for cutting of watersensitive materials</p> <p>5 l</p>	<p>49900070</p>
<p><i>Tube for Water-free Cutting</i> Pump tube for use with Water-free Cutting Fluid</p> <p>1 pc.</p>	<p>05996921</p>
<p><i>Dressing stick</i> Aluminium oxide stick.</p> <p>1 pc.</p>	<p>40800044</p>

Visit the Struers e-shop to see the latest additions to the Struers consumables range. [www.e-shop.struers.com](http://www.e-shop.struers.com).

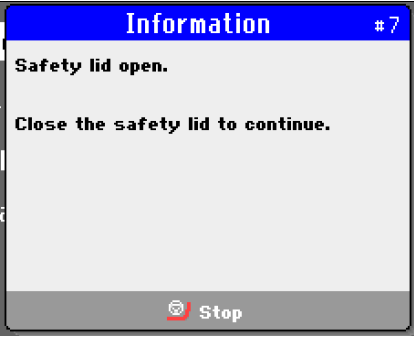
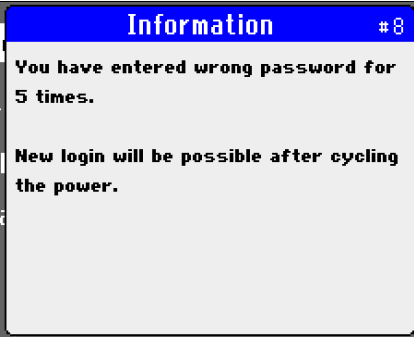
### 3. Trouble-Shooting

Message	#	Explanation	Action
	1		Re-start. If error remains, contact Struers Service. Please make a note of the <i>Reason code</i> displayed
	7	Guard opened when starting a process.	Close the guard to continue in process. If the guard is closed check that the safety lock release is re-activated.
	8		Restart the machine and enter the correct Pass code. Reset the machine to factory settings if the Pass code is forgotten.
	12	The database storing capacity has been reached.	Delete one or more of the methods – this will free space to store new methods. Nb! it is not possible to delete Struers Methods.

Accutom-100  
Instruction Manual

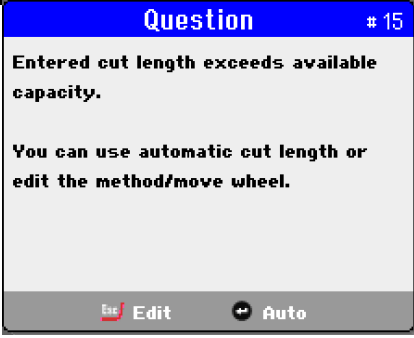
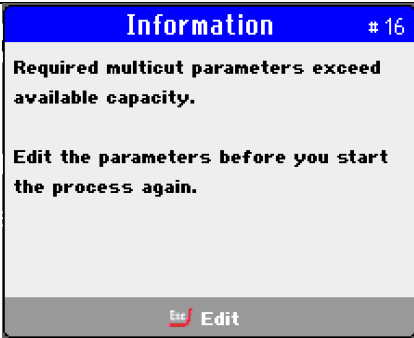
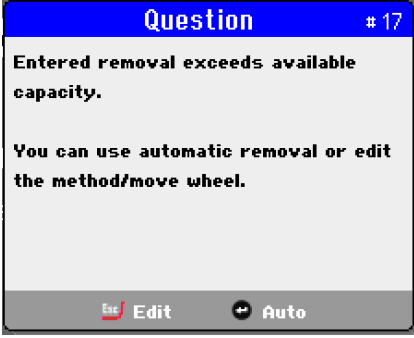
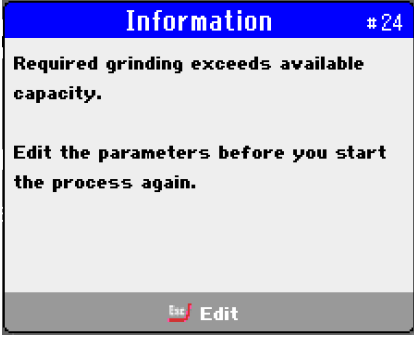
Message	#	Explanation	Action
 <p><b>Question # 15</b> Entered cut length exceeds available capacity. You can use automatic cut length or edit the method/move wheel. Edit Auto</p>	15	Not enough space for the selected cut length.	<b>Yes</b> – the machine will cut to the max. available length. <b>No</b> –Edit the Length of cut or re-position the workpiece.
 <p><b>Information # 16</b> Required multicut parameters exceed available capacity. Edit the parameters before you start the process again. Edit</p>	16	Not enough space for the selected MultiCut process.	Edit the method or re-position the workpiece.
 <p><b>Question # 17</b> Entered removal exceeds available capacity. You can use automatic removal or edit the method/move wheel. Edit Auto</p>	17	Not enough space for the grinding process.	<b>Yes</b> – the machine will grind to the max. available length. <b>No</b> – Edit the method or re-position the specimen.
 <p><b>Information # 24</b> Required grinding exceeds available capacity. Edit the parameters before you start the process again. Edit</p>	24	Not enough space for the grinding process.	Edit grinding parameters or re-position the specimen.



Accutom-100  
Instruction Manual

Message	#	Explanation	Action
<div style="background-color: #f96; padding: 2px; text-align: center;"><b>Warning</b> #27</div> <p>Communication with Real Time Clock (RTC) failed. Time/date stamp cannot be used for event log.</p> <p>Try to reboot the machine. If the problem persists please contact Struers technical support.</p> <div style="background-color: #ccc; padding: 2px; text-align: center;">↔ Accept</div>	27		Re-start. If error remains, contact Struers Service.
<div style="background-color: #0056b3; color: white; padding: 2px; text-align: center;"><b>Information</b> #35</div> <p>Main motor is overheated.</p> <p>Let the motor cool down and then continue with lower feed speed and/or lower force.</p> <div style="background-color: #ccc; padding: 2px; text-align: center;">↔ Accept</div>	35		Wait until the motor has cooled down approx. 20-30 minutes and then continue with lower load.
<div style="background-color: #d62728; color: white; padding: 2px; text-align: center;"><b>Error</b> #42</div> <p>Problem with safety wiring detected.</p> <p>Restart machine. If problem persists after restart contact Struers technical support.</p> <div style="background-color: #ccc; padding: 2px; text-align: center;">↔ Accept</div>	42		Check that the safety lock release is activated. Then restart the machine.
<div style="background-color: #0056b3; color: white; padding: 2px; text-align: center;"><b>Information</b> #50</div> <p>Frequency inverter reported an error. Process halted.</p> <p>Error code is on bottom.</p> <p>0</p> <div style="background-color: #ccc; padding: 2px; text-align: center;">↔ Accept</div>	50		Contact Struers Service. Please make a note of the <i>Error code</i> displayed.

Accutom-100  
Instruction Manual

Message	#	Explanation	Action
	27		Re-start. If error remains, contact Struers Service.

Error	Explanation	Action
<b>Machine Problems</b>		
No, or insufficient cooling fluid.	Level in the cooling fluid tank too low.	Check that there is sufficient water in the Cooling fluid tank.
	Cooling fluid nozzles blocked.	Clean the nozzles.
Water leaking.	Leak in the Cooling fluid tube.	Check the Cooling Pump Tube. Replace if necessary.
	Water overflow in the cooling fluid tank.	Remove the excess water.
	The basket for cutting debris is blocked.	Clean the basket.
Workpieces rusty.	Insufficient additive in cooling fluid.	Check the concentration of Cooli Additive in the cooling fluid. Follow the instructions in the ' <a href="#">Maintenance</a> ' Section.
Cutting chamber rusty.	Insufficient additive in cooling fluid.	Check the concentration of Cooli Additive in the cooling fluid. Follow the instructions in the ' <a href="#">Maintenance</a> ' Section.
	The guard is left closed after use.	Leave the guard open to let the cutting chamber dry.
Cutting chamber shows signs of corrosion.	The workpiece is made of Copper/ Copper Alloy.	Use Corrozip-Cu.

*Accutom-100  
Instruction Manual*

Error	Explanation	Action
<b>Cutting Problems</b>		
Discoloration or burning of the workpiece.	The hardness of the cut-off wheel is inappropriate for the hardness / dimensions of the workpiece.	Select another wheel. Alternatively, reduce rotational speed. <b>HINT:</b> Refer to the <a href="#">Brochures</a> for details of the range available.
	Inadequate cooling.	Check the positioning of the cooling fluid nozzles. If necessary, clean the nozzles.
		Check that there is sufficient water in the Cooling fluid tank.
		Check the concentration of Cooli Additive in the cooling fluid.
Unwanted burrs.	Cut-off wheel too hard.	Select another wheel. Alternatively, reduce rotational speed <b>HINT:</b> Refer to the <a href="#">Brochures</a> for details of the range available.
	Feed speed too high at the end of the operation.	Reduce the feed speed near the end of the operation.
	Incorrect clamping of the workpiece.	Clamp the workpiece securely, e.g. Struers' Specimen Holder CATAL, which is designed for clamping longer workpieces on both sides. <b>HINT:</b> Refer to the <a href="#">Accutom-10/-100 Brochure</a> for details of the range of Specimen Holders available.
Cutting quality differs.	Inadequate cooling.	Check the positioning of the cooling fluid nozzles. If necessary, clean the nozzles
		Check that there is sufficient water in the Cooling fluid tank.
		Check the concentration of Cooli Additive in the cooling fluid.

*Accutom-100  
Instruction Manual*

<b>Error</b>	<b>Explanation</b>	<b>Action</b>
Cut-off wheel breaks.	Incorrect mounting of the cut-off wheel.	Check that the bore/centre hole has the correct diameter. The nut must be tightened properly.
	Incorrect clamping of the workpiece.	Clamp the workpiece securely, e.g. Struers' Specimen Holder CATAL which is designed for clamping longer workpieces on both sides. <b>HINT:</b> Please refer to the <a href="#">Accutom Brochure</a> for details of the range of Specimen Holders available.
	Cut-off wheel is too hard.	Select another wheel. Alternatively, reduce rotational speed. <b>HINT:</b> Refer to the <a href="#">Brochures</a> for details of the range available.
	Feed speed is set too high.	Reduce the feed speed.
	Force level is set too high.	Reduce the Force level.
	Cut-off wheel bends on contact with the workpiece.	Make an initial cut at a lower feed speed.
The cut-off wheel wears down too quickly.	The feed speed is too high.	Reduce feed speed.
	The rotational speed is too low.	Increase rotational speed.
	Insufficient cooling.	Check that there is enough water in the Cooling fluid tank. Check the positioning of the cooling fluid nozzles. If necessary, clean the nozzles.
The cut-off wheel does not cut through the workpiece.	The rotational speed is too low.	Increase rotational speed.
	Incorrect choice of cut-off wheel.	Refer to the <a href="#">Brochures</a> for details of the range available.
	Cut-off wheel worn.	Replace the cut-off wheel.

*Accutom-100  
Instruction Manual*

Error	Explanation	Action
The workpiece breaks when clamped.	The cut-off wheel gets caught in the workpiece during cutting.	Clamp the workpiece on both sides of the cut-off wheel so that the cut stays open, e.g. Struers' Specimen Holder CATAL, which is designed for clamping longer workpieces on both sides. <b>HINT:</b> Refer to the <a href="#">Accutom Brochure</a> for details of the range of Specimen Holders available.
	The workpiece is brittle.	Place the workpiece between two plastic/rubber plates. Alternatively, mount the workpiece. For further information, see the section on <i>Mounting</i> on the Struers website. <b>NOTE:</b> Always cut brittle workpieces very carefully.
The specimen is corroded	The specimen has been left in the cutting chamber for too long.	Remove the specimen directly after cutting. Leave the cutting chamber guard open when you leave the machine.
	Insufficient additive for cooling fluid.	Check the concentration of Cooli Additive in the cooling fluid.

## 4. Service

Accutom offers extensive information about the conditions of all different components.



**HINT:**

Service information is only available in English

To reach this function:

- Go to the *Maintenance* menu and select: *Service functions*.

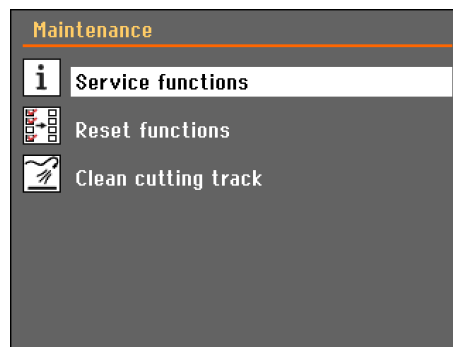

Various topics can be selected for information on the condition of the different components.

Service information can also be used in cooperation with Struers Service for remote diagnostics of the equipment.

Service information is read-only information, machine settings cannot be changed or modified.

Information on total operation time and servicing of the machine is displayed on the screen at start-up:



A reminder will appear after 1,400 hours operation time to remind the user that a service check should be scheduled.

After the 1,500 hours operation time has been exceeded the Service-Info will change to alert the user that the recommended service interval has been exceeded: "Service period expired!"

- Contact Struers Service to service the machine.

## Service Check



**NOTE:**

Servicing may only be performed by a Struers engineer or a qualified technician (electromechanical, electronic, mechanical, pneumatic, etc.).

Contact Struers Service for information.

Struers recommends that a regular service check be carried out after every 1,500 hours of use.

Struers offers a range of comprehensive maintenance plans to suit the requirements of our customers. This range of services is called **ServiceGuard**.

The maintenance plans include equipment inspection, replacement of wear parts, adjustments/calibration for optimal operation, and a final functional test.

## 5. Spare Parts and Diagrams

For further information, or to check the availability of other replacement parts, please contact your local Struers Service department. Contact information is available on [Struers.com](http://Struers.com).

### Safety Related Parts of the Control System (SRP/CS)

Safety Related Part	Manufacturer / Manufacturer Description	Manufacturer Cat. no.
Interlock locking device	Schmersal Solenoid interlock	AZM 170SK-11-02ZRK -2197, 24 VAC/DC
Frequency inverter	Schneider Freq.Inv. 1x200-240V 550W 200-240V, 50/60Hz	ATV320U06M2C
Emergency Stop button	Schlegel Latching Mushroom Head	ES Ø22 type RV
Emergency Stop contact	Schlegel Modular Contact, momentary	1 NC type MTO
Module holder	Schlege Module holder. 5 elem. MHR-5	MHR-5
Guard	Struers	16170044
Magnetic sensor	Schmersal magnetic sensor	BNS-120-02z
Safety relay unit	Omron safety relay	G9SB-3012-A
Speed monitoring card	REER speed monitoring card	SV MR0
Speed sensor – main motor	Balluff Temperature-rated inductive sensors	BES05RP
Speed sensor Y-movement	Sick Inductive proximity sensors	IMB08-02BPSVU2K
Hold-To-Run button	Schurter Metal line switches	1241.6931.1120000
Lock relay	Finder Relay interface modules	38.51.0.024.0060

Struers' Cat. No. are listed in the Spare Parts list





**WARNING**

Safety critical components are to be replaced after a maximum lifetime of 20 years.

The guard must be replaced after a lifetime of 3 years.

Contact Struers Service for information.



**NOTE:**

Replacement of Safety critical components can only be performed by a Struers engineer or a qualified technician (electromechanical, electronic, mechanical, pneumatic, etc.).

Safety critical components may only be replaced by components with at least the same safety level.

Contact Struers Service for information.

**Spare Parts List**

<b>Spare Part</b>	<b>EI.Ref.</b>	<b>Cat no:</b>
Interlock locking device	YS1	2SS00025
Frequency inverter	A2	2PU32056
Emergency Stop button	S1	2SA10400
Emergency Stop contact	S1	2SB10071
Module holder	S1	2SA41605
Guard	-	16170044
Magnetic sensor	SS1	2SS00130
Safety relay unit	KS1, KS3	2KS10006
Speed monitoring card	KS2, KS4	2KS10034
Speed sensor – main motor	HQ3, HQ4	2HQ50502
Speed sensor – Y-movement	HQ5, HQ6	2HQ00032
Hold-To-Run button	S2	2SA00023
Lock relay, Liquid relay	K1, K2	2KL23851

**Diagrams**

<b>Title</b>	<b>No.</b>
<a href="#">Block Diagram, Accutom</a>	16173051
<a href="#">Circuit Diagram, Accutom</a> (4 pages)	16173101
<a href="#">Air Diagram, Accutom</a>	16171004
<a href="#">Water Diagram, Accutom</a>	16171003

See the following pages.

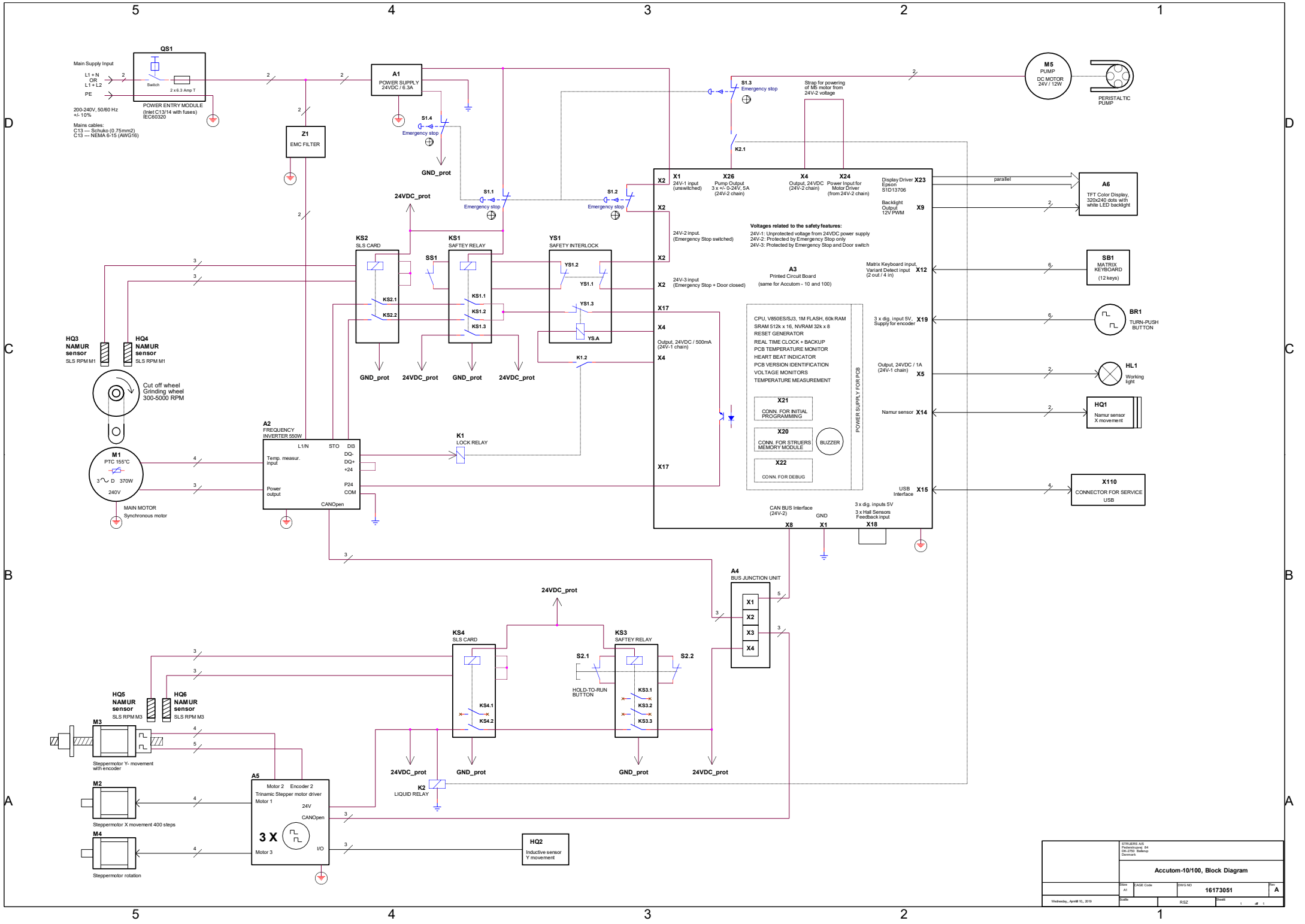

STRUKTUR A3 Ersatzteil Nr. 44 26/2018 Release Demeter			
<b>Accutom-10/100, Block Diagram</b>			
Rev. 01	Edat Code	Doc No	16173051
Path	RSZ	Form	1
Wednesday, April 10, 2019			



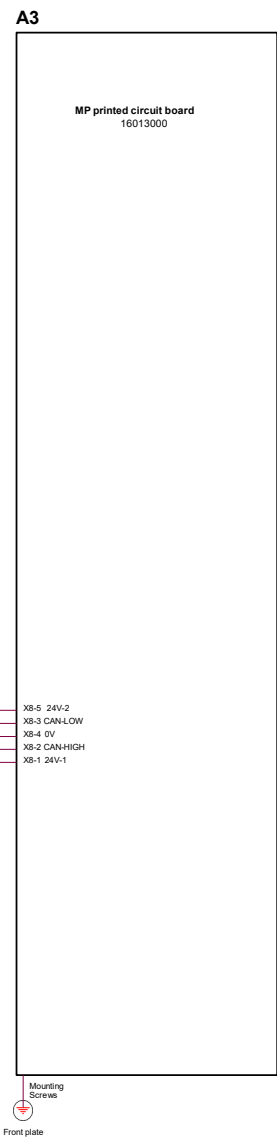
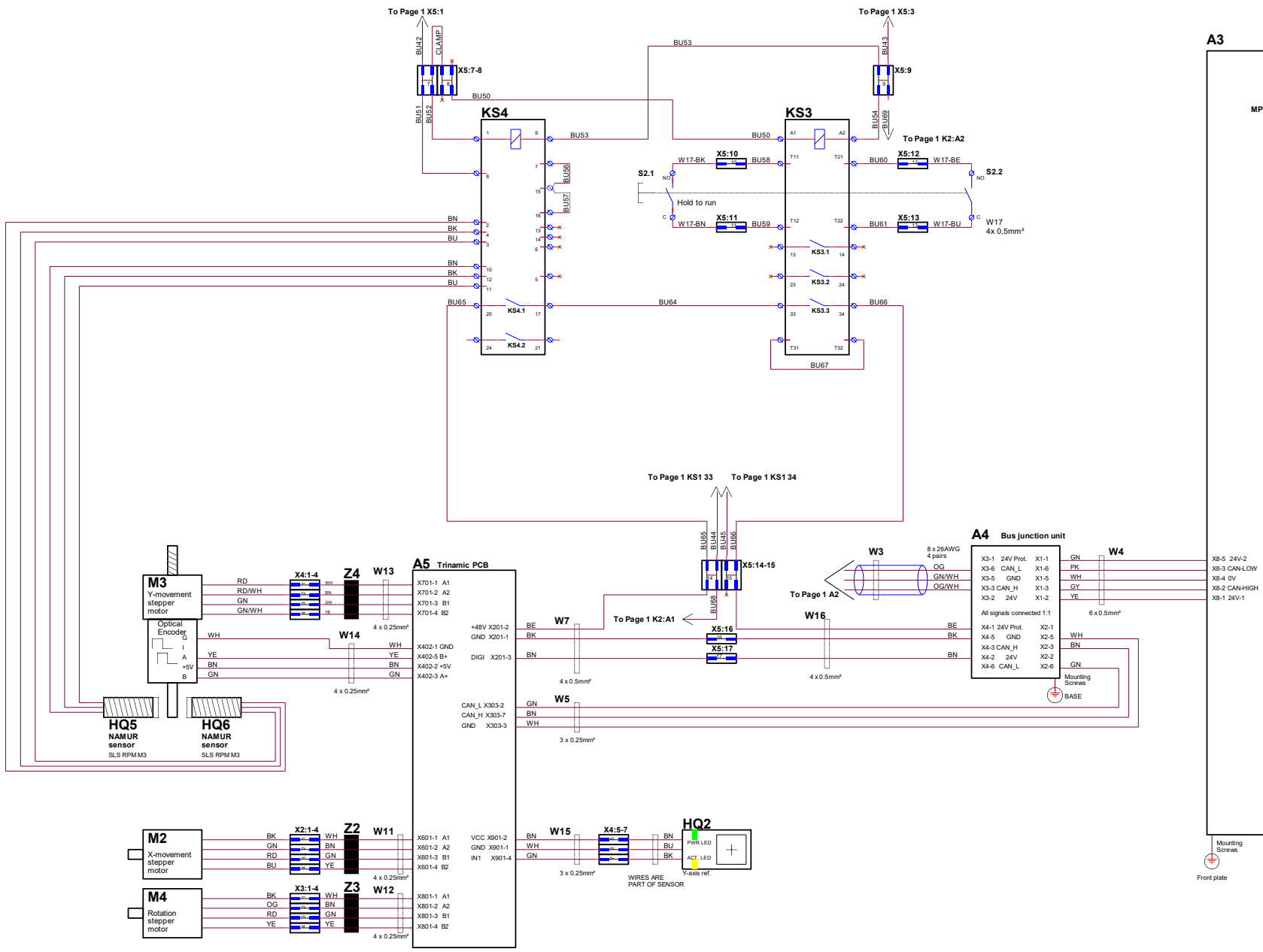

REV A RSZ		STRUCTURE AS REV 2019 08 14 Drawing	
<b>Accutom - 10/100, Circuit Diagram SLS</b>			
REV: A1	PAGE: 006	DWG NO:	16173101
DATE: 16/08/2019	DESIGNER: RSZ	CHECKED:	2 of 4

A3

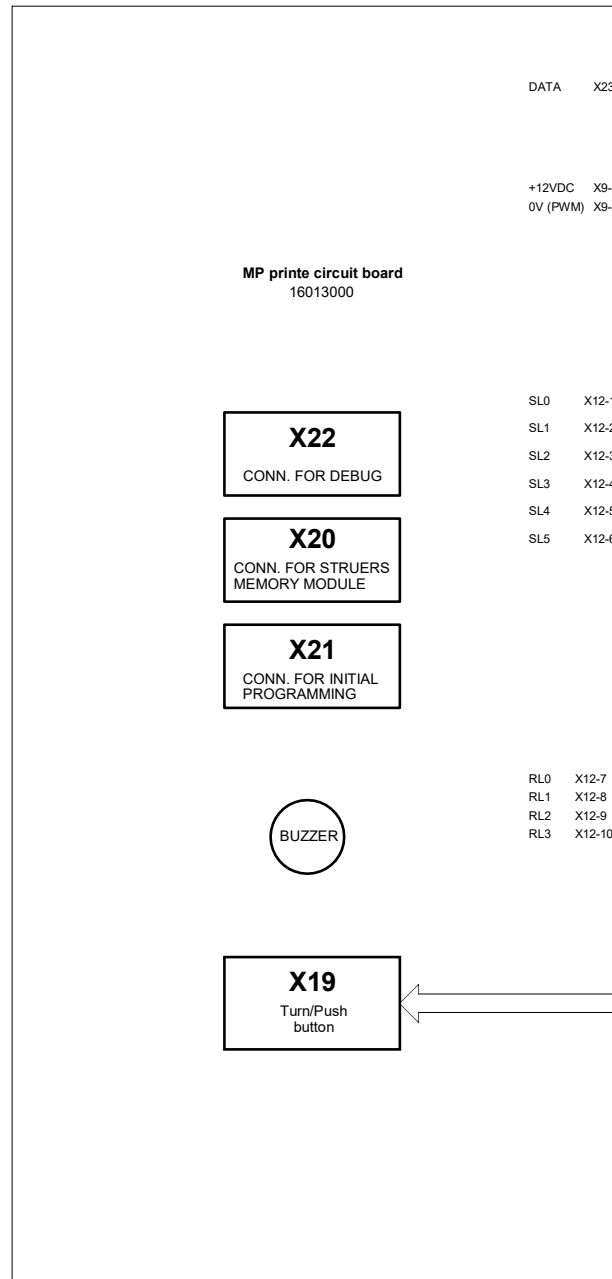

- DATA X23
- +12VDC X9-1
- 0V (PWM) X9-2
- SL0 X12-1
- SL1 X12-2
- SL2 X12-3
- SL3 X12-4
- SL4 X12-5
- SL5 X12-6
- RL0 X12-7
- RL1 X12-8
- RL2 X12-9
- RL3 X12-10

W10

40 wire flat cable 0.5mm pitch



2x 0.25mm<sup>2</sup>

A6

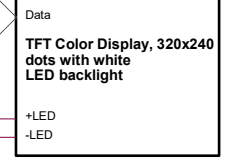

SB1

Matrix Keyboard

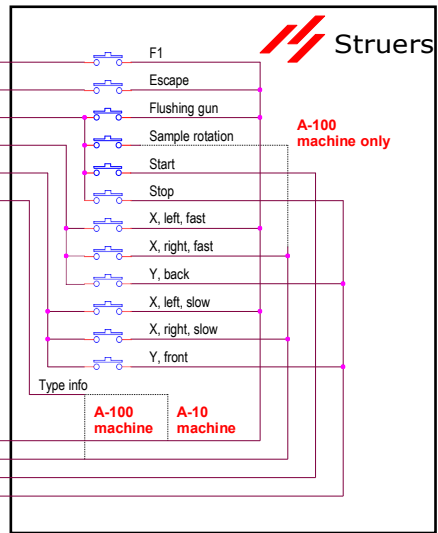

BR1

Turn/Push Button

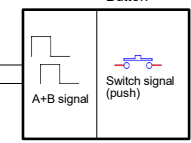

6 wire flat cable

- COLOR CODE:
- BK = black
  - BN = brown
  - RD = red
  - OG = orange
  - YE = yellow
  - GN = green
  - BU = blue
  - VT = violet
  - GY = grey
  - WH = white
  - PK = pink
  - BE = beige
  - RO = rose
  - GNYE = yellow-green

REV: RSZ		STRUERS A/S Pødenstugvej 84 DK-2720 Ballerup Denmark	
<b>Accutom - 10/100, Circuit Diagram CONTROL PANEL</b>			
Size A2	EAGE Code	DWG NO <b>16173101</b>	Rev <b>A</b>
Scale		RSZ	Sheet 3 of 4
Wednesday, August 29, 2016			

**CAUTION - Risk of electric shock.**  
 Disconnect all power and wait 15 min. before servicing.

External short circuit protection according to local regulations.

Main Supply Input  
 200-240V, 50/60 Hz  
 +/- 10%

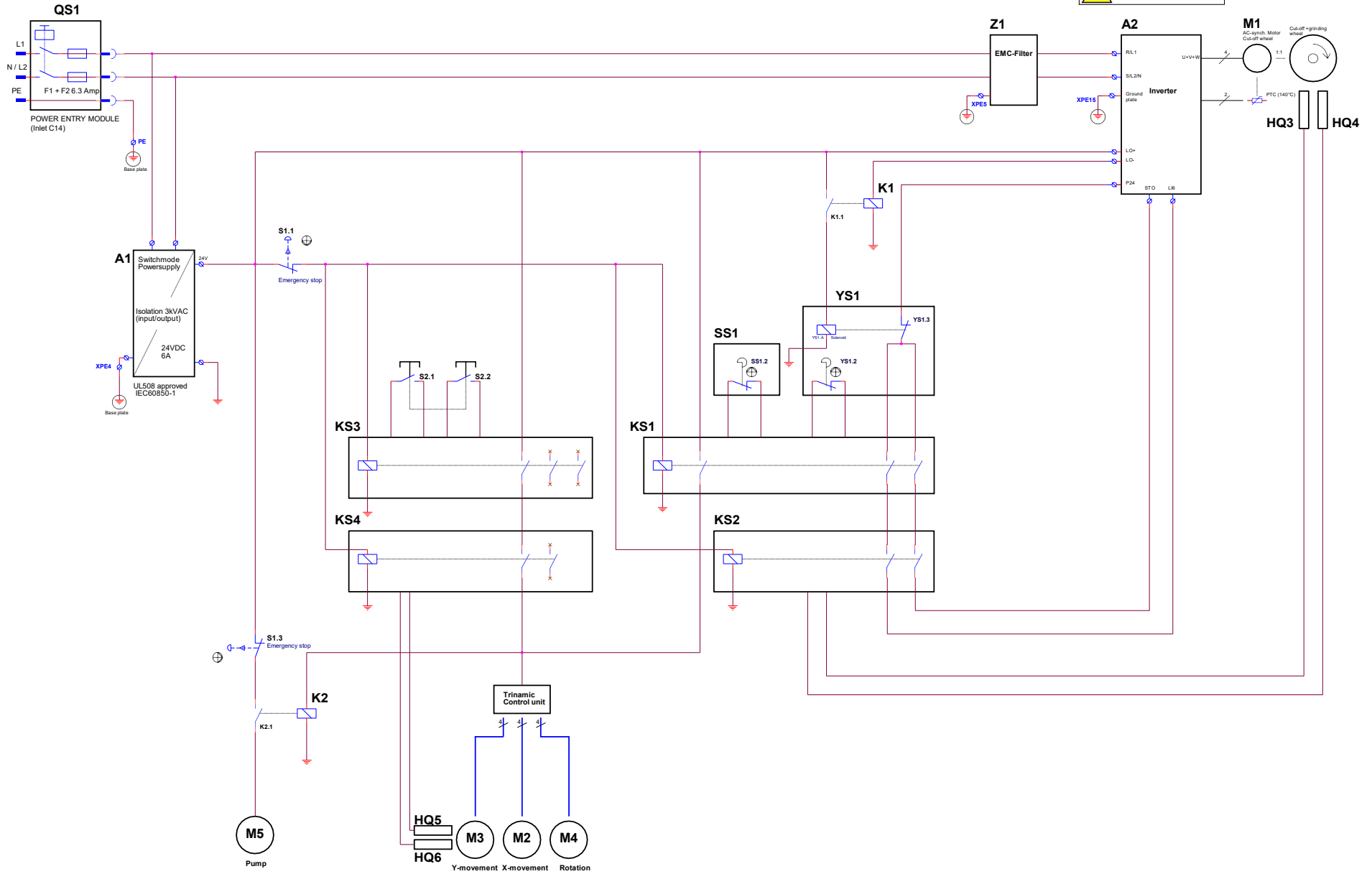



REV A: RSZ	TRINAMIC AG Technischer Support Deutschland		
<b>Accutum - 10/100, Safety circuit</b>			
0001	PAGE: 0001	DRWG NO:	16173101
0001	RSZ	0001	A
Tumshu, February 01, 2019			

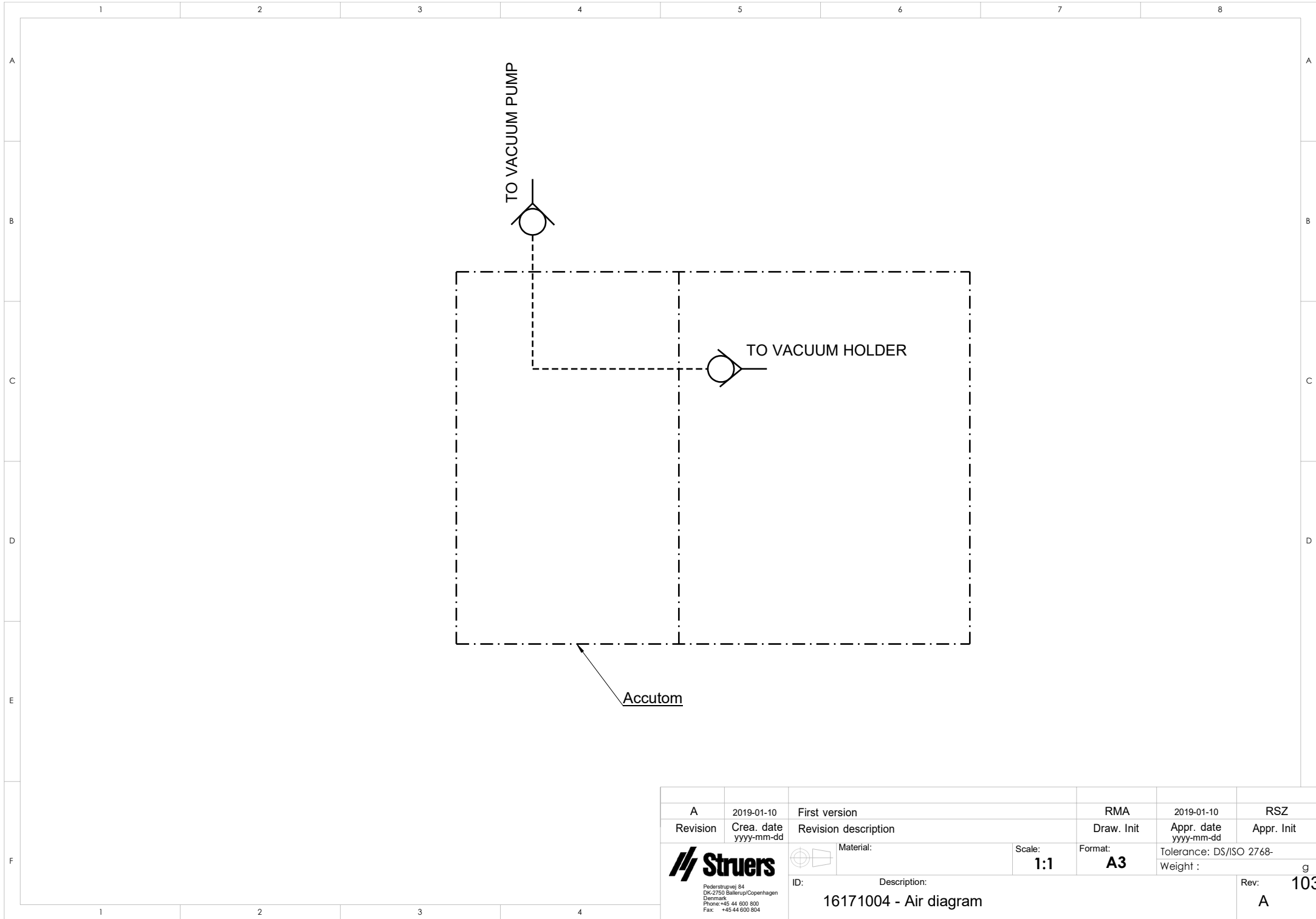



Accutom

A	2019-01-10	First version	RMA	2019-01-10	RSZ
Revision	Crea. date yyyy-mm-dd	Revision description	Draw. Init	Appr. date yyyy-mm-dd	Appr. Init
 <small>Pederstrupvej 84 DK-2750 Ballerup/Copenhagen Denmark Phone: +45 44 600 800 Fax: +45 44 600 804</small>		Material:	Scale: <b>1:1</b>	Format: <b>A3</b>	Tolerance: DS/ISO 2768- Weight :
		ID:	Description: <b>16171004 - Air diagram</b>	Rev: <b>A</b>	<b>103</b> g

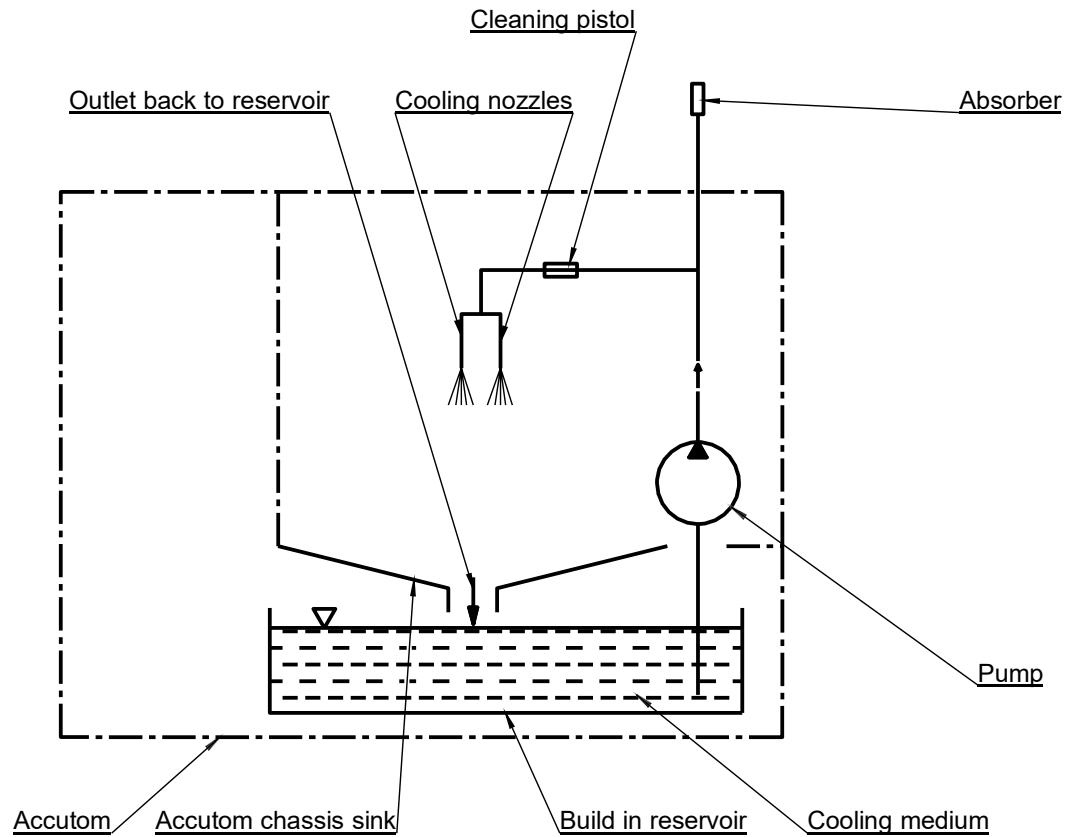

A	2018-11-20		RMA	2019-03-26	RSZ
Revision	Crea. date yyyy-mm-dd	Revision description	Draw. Init	Appr. date yyyy-mm-dd	Appr. Init
		Material:	Scale: <b>1:1</b>	Format: <b>A3</b>	Tolerance: DS/ISO 2768- Weight : g
<small>Pedersbølvej 84 DK-2750 Ballerup/Copenhagen Denmark Phone: +45 44 600 800 Fax: +45 44 600 804</small>		ID:	Description: <b>16171003 Water diagram</b>		Rev: <b>A</b>

## **6. Legal and Regulatory**

### **FCC Note**

This equipment has been tested and found to comply with the limits for a Class A digital device, pursuant to Part 15 of the FCC Rules. These limits are designed to provide reasonable protection against harmful interference when the equipment is operated in a commercial environment. This equipment generates, uses, and can radiate radio frequency energy and, if not installed and used in accordance with the Instruction Manual, may cause harmful interference to radio communications. Operation of this equipment in a residential area is likely to cause harmful interference in which case the user will be required to correct the interference at his own expense.

Pursuant to Part 15.21 of the FCC Rules, any changes or modifications to this product not expressly approved by Struers ApS could cause harmful radio interference and void the user's authority to operate the equipment.

### **EN ISO 13849-1:2015**

Safety parts of the control system (SRP/CS) have been evaluated according to EN 13849-1:2015 and EN 60204-1:2006. All SRP/CS are limited to a lifetime of 20 years. After expiration of this period, all components must be replaced.

## 7. Technical Data

Subject	Specifications
Specimen holder rotation and oscillation	Yes
Automatic rotation of specimen holder	Yes
Motor rotation speed	300-5000 rpm adjustable in steps of 50 rpm
Grinding – Feed speed:	0.5 - 7.5 mm/s adjustable in steps of 0.5 mm/s
Cutting – Feed speed:	0.005 - 3 mm/s adjustable in steps of 0.005 mm/s
Positioning speed	Y= 13 mm/s X= 10 mm/s
Positioning range	X direction: 60 mm (precision 0.005 mm) Y direction: 110 mm (precision 0.1 mm)
<b>Physical specifications</b>	
<b>Cutting capacity</b>	
Cut-off wheel:	75 mm - 150 mm (3 - 6") dia. Arbor size: 12.7 mm
Length of cut-off specimen:	40 mm / 195 mm (1.6" / 7.7") for 25 mm dia.
Length of workpiece to be clamped:	250 mm (9.8")
Workpiece width and height:	50 x 130 mm (2" x 5.1")
Workpiece cross section:	54 mm (2.1") without rotation / 108 mm (4.2") with rotation
<b>Grinding capacity</b>	
Cup wheel:	100 mm - 150 mm dia. (4 - 6") dia. Arbor size: 12.7 mm
Specimen:	95 x 95 mm (3.7" x 3.7")

*Accutom-100  
Instruction Manual*

Subject	Specifications
<b>Software and electronics</b>	
Controls	Touch pad and push/turn knob
Memory	FLASH-ROM/RAM/NV-RAM
LC Display	TFT-colour 320 x 240 dots with LED back light
<b>Operating environment</b>	
Noise level <sup>6</sup>	A-weighted sound emission pressure level at workstations. L <sub>PA</sub> = 67 dB(A) (measured value) Uncertainty K = 4 dB(A) Measurements made in accordance with EN ISO 11202.
Operational temperature	5 – 40 °C / 41 – 104 °F
Operational humidity	35 - 85 % RH, non-condensing
Storage temperature	-25 – 55 °C / -13 – 113 °F
Storage humidity	< 85 % RH, non-condensing
<b>EU Directives</b>	Please refer to the Declaration of Conformity
<b>Recirculation cooling unit</b>	
Contents	4.75 l (1¼ gallon)
Flow	1.6 l/min. (0.4 gallon/min.)
<b>Supply</b>	
Voltage / frequency	200-240 V / 50-60 Hz
Power inlet	1-phase (N+L1+PE) or 2-phase (L1+L2+PE) The electrical installation must comply with "Installation Category II".
Power, nominal load	1080 W
Power, idle	45 W
Current, nom.	4.5 A
Current, max.	9.1 A
Current, largest load	1.45 A

<sup>6</sup> Noise level: The figures quoted are emission levels and are not necessarily safe working levels. While there is a correlation between the emission and exposure levels, this cannot be used reliably to determine whether or not further precautions are required. Factors that influence the actual level of exposure of the workforce include characteristics of the work room, the other sources of noise, etc., i.e. the number of machines and other adjacent processes. Also, the permissible exposure level can vary from country to country. This information, however, will enable the user of the machine to make a better evaluation of the hazard and risk.

*Accutom-100  
Instruction Manual*



<b>Subject</b>	<b>Specifications</b>
<b>EU Directives</b>	Please refer to the Declaration of Conformity
<b>Safety Circuit Categories</b>	
Guard safety switch system	EN60204-1, Stop Category 0 EN ISO 13849-1, Cat. 3, PL d
Guard lock	EN60204-1, Stop Category 0 EN ISO 13849-1, Cat. 3, PL b
Hold-to-run function	EN60204-1, Stop Category 0 EN ISO 13849-1, Cat. 3, PL d
Emergency stop	EN60204-1, Stop Category 0 EN ISO 13849-1, Cat. 1, PL c
Unintended start of fluid system	EN ISO 13849-1, Cat. 3, PL b
Speed monitoring - cut-off wheel/cup wheel console movement	EN60204-1, Stop Category 0 EN ISO 13849-1, Cat. 3, PL d
Rotation speed of cut-off wheel/cup wheel monitoring.	EN ISO 13849-1, Cat. 3, PL d
<b>Exhaust</b>	50 mm / 2" dia. Minimum capacity: 30 m <sup>3</sup> /h / 1,060 ft <sup>3</sup> /h at 0 mm / 0" water gauge.
<b>Dimensions</b>	
Height	44 cm (17.3") guard closed 106.5 cm (42") guard open
Width	65 cm (25")
Depth	71 cm (28") 78 cm (30.9") with plug
Weight	68 kg

# **Appendix:**

## Accutom-10/-100, Pre-Installation Checklist

**Read the Installation instructions in the Instruction Manual  
before  
installing the machine.**

### Installation Requirements

- Crane and 2 lifting straps <sup>7</sup>
- Screwdriver/ bit: TX30 , PH2  and H4 

Required Accessories and Consumables (ordered separately)  
(Please refer to the [Accutom Brochure](#) and the [Struers Consumables Catalogue](#) for details of the range available).

Recommended  
Exhaust system: 30 m<sup>3</sup>/h / 1,060 ft<sup>3</sup>/h at 0 mm/0" water gauge

### Crating Specifications

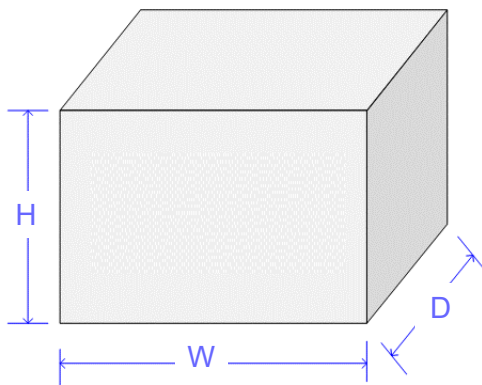

	Accutom-10	Accutom-100
<b>H</b>	88 cm / 34.6"	
<b>W</b>	92 cm / 36"	
<b>D</b>	92 cm / 36"	
<b>Weight</b>	103 kg / 227 lbs	106 kg / 234 lbs

<sup>7</sup>  
Straps must be approved for at least twice the weight of the load.



## Unpacking

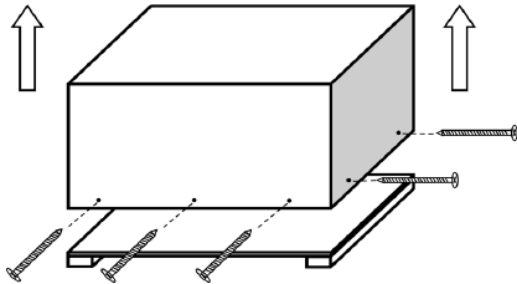

- Carefully open and remove the sides and the top of the packing crate.
- Remove the transport brackets securing the machine to the pallet.

## Location

The machine must be placed close to the power supply. The machine is designed to be placed on a rigid, stable workbench with a horizontal surface. Ensure that the work station has adequate lighting. Avoid direct glare (dazzling light sources within the operator's line of vision) and reflected glare (reflections of light sources).

*Recommended dimensions:*

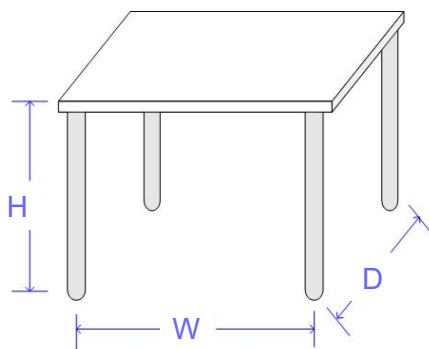

Height: Recommended 80 cm / 31.5"

Width: min. 70 cm / 27.6"

Depth: min. 80 cm / 31.5"



### **HINT:**

A table unit designed for Struers' table top machines is available as an accessory Cat. No. 06266101.

### **Recommended Space**

To facilitate easy access for service technicians, allow sufficient space around the machine.

#### **Front:**

Recommended space at the front: 100 cm / 40".

#### **Rear:**

The machine may be placed against a wall.

- Check there is enough room behind the table for the cover to be opened fully (see illustration).
- Check there is approx. 15 cm / 5.9" behind the machine for the exhaust hose.

Accutom-10/-100,  
Pre-Installation Checklist

**Dimensions**

**Front**

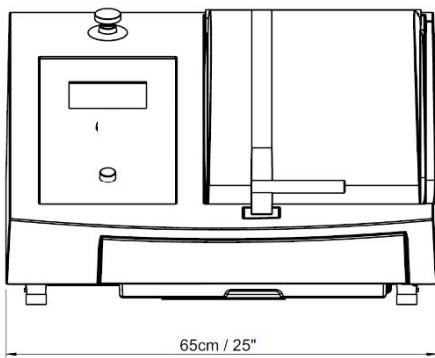

**Side**

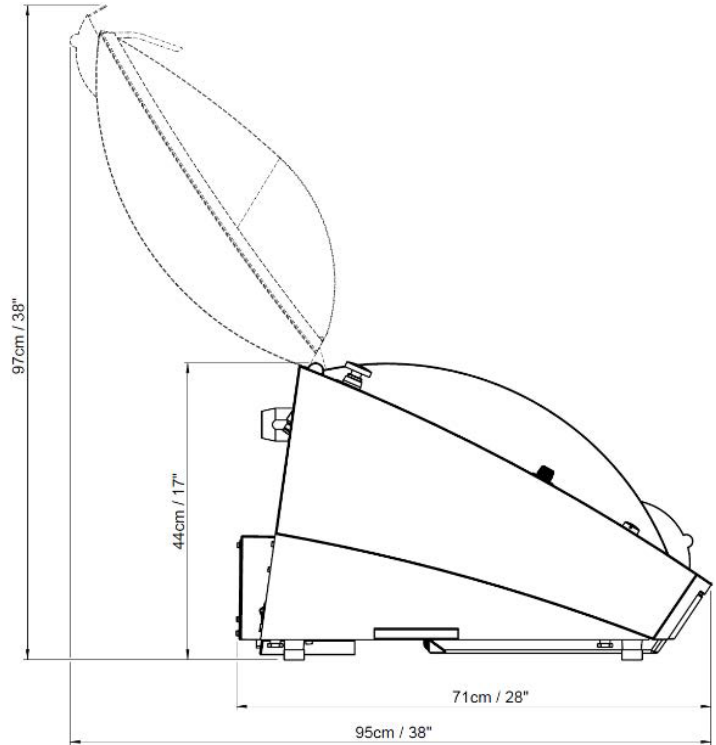

**Centre of Gravity**

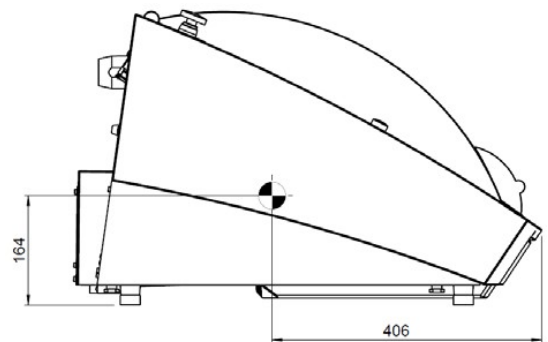
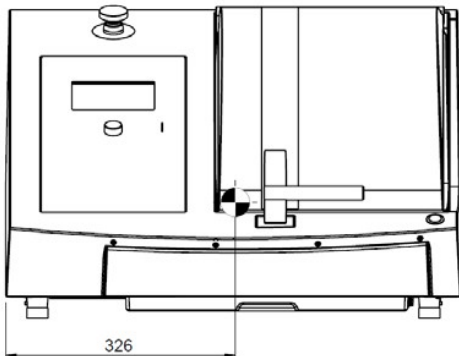

## Lifting



**NOTE:**

Do not lift Accutom using the light grey body.  
Remove the recirculation tank before lifting Accutom.  
Always lift from underneath the machine.

*With a crane*

A crane and 2 lifting straps are required to lift the machine off the shipment pallet. A lifting bar is recommended so that the two straps are kept apart below the lifting point.

- Remove the recirculation tank.
- Place the two lifting straps under Accutom.
  - Position the straps under Accutom, so that they are on the inside of the feet. See drawing.

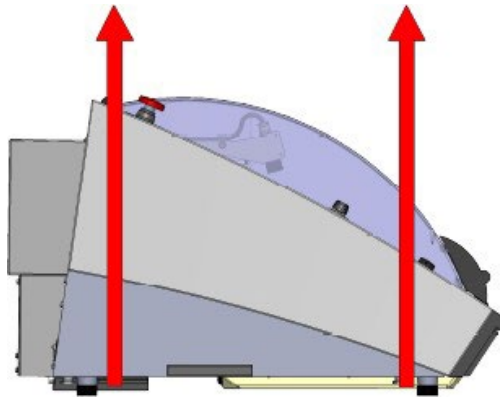

- Lift Accutom onto the table.
- Lift the front of Accutom and carefully move into place.

## Power Supply

### The mains plug

The mains plug must be easily accessible and be between 0.6 m and 1.9 m above the ground. (An upper limit of 1.7 meters is recommended).

The machine shipped with 2 types of Mains cables (length 2.5 m/ 8.2').

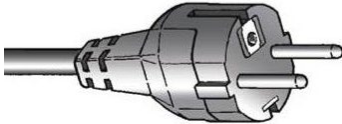

The 2-pin (European Schuko) plug:  
- single-phase connections.

If the plug supplied on this cable is not approved in your country, then the plug must be replaced with an approved plug.

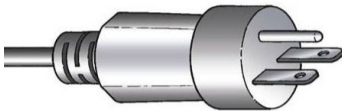

The 3-pin (North American NEMA 6-15P) plug:  
- 2-phase connections.

If the plug supplied on this cable is not approved in your country, then the plug must be replaced with an approved plug.

### Electrical data

	<b>Accutom-10/100</b>
Voltage / frequency	200-240 V / 50-60 Hz
Power inlet	1-phase (N+L1+PE) or 2-phase (L1+L2+PE) The electrical installation must comply with "Installation Category II".
Power, nominal load	1080 W
Power, idle	45 W
Current, nom.	4.5 A
Current, max.	9.1 A
Current, largest load.	1.45 A

## Safety Specifications

### Safety Circuit Categories

<b>Designed to comply with a minimum of</b>	
Guard safety switch system	EN60204-1, Stop Category 0 EN ISO 13849-1, Cat. 3, PL d
Guard lock	EN60204-1, Stop Category 0 EN ISO 13849-1, Cat. 3, PL b
Hold-to-run function	EN60204-1, Stop Category 0 EN ISO 13849-1, Cat. 3, PL d
Emergency stop	EN60204-1, Stop Category 0 EN ISO 13849-1, Cat. 1, PL c
Unintended start of fluid system	EN ISO 13849-1, Cat. 3, PL b
Speed monitoring – cut-off wheel/cup wheel console movement	EN60204-1, Stop Category 0 EN ISO 13849-1, Cat. 3, PL d
Rotation speed of cut-off wheel/cup wheel monitoring.	EN ISO 13849-1, Cat. 3, PL d
Guard safety switch system	EN60204-1, Stop Category 0 EN ISO 13849-1, Cat. 3, PL d

*Accutom-10/-100,  
Pre-Installation Checklist*

<b>Water Supply</b>	<input type="checkbox"/> <b>Required</b>	<input checked="" type="checkbox"/> <b>Option</b>
---------------------	--	---

Cooling fluid is supplied from the integrated recirculation unit (capacity 4.75 l / 1.25 gallon).  
A kit for connection to an external recirculation unit is available as an optional accessory.

<b>Water outlet – Drain</b>	<input type="checkbox"/> <b>Required</b>	<input type="checkbox"/> <b>Option</b>
-----------------------------	--	--

The machine is supplied with a small drain hose, which directs the cooling fluid into the recirculation unit.

<b>Compressed air</b>	<input type="checkbox"/> <b>Required</b>	<input type="checkbox"/> <b>Option</b>
-----------------------	--	--

**Not required.**

<b>Exhaust</b>	<input type="checkbox"/> <b>Required</b>	<input checked="" type="checkbox"/> <b>Option</b>
----------------	--	---

**Recommended:**

Minimum capacity: 30 m<sup>3</sup>/h / 1,060 ft<sup>3</sup>/h at 0mm /0" water gauge.

**Exhaust connection:**

The machine is supplied with an exhaust hose 1.5 m / 4.9' long with a diameter 50 mm / 2"

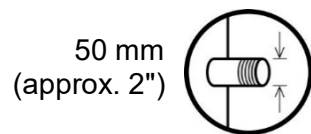

*Accutom-10/-100,  
Pre-Installation Checklist*

<b>Vacuum pump</b>	<input type="checkbox"/> <b>Required</b>	<input checked="" type="checkbox"/> <b>Option</b>
--------------------	--	---

Accutom-100 can be used with a vacuum chuck which requires that a vacuum pump is connected to the machine.  
The Vacuum pump must be able to create at least 900 mbar vacuum.

## **Ambient Conditions**

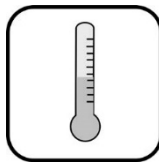

5 - 40 °C  
41 - 104 °F



< 85 % RH non condensing

## **Accessories & Consumables**

Please refer to the [Accutom Brochure](#) and the [Struers Consumables Catalogue](#) for details of the range available.

### **Consumables**

The use of Struers consumables is recommended.  
Other products (e.g. coolants) may contain aggressive solvents, which dissolve e.g. rubber seals. The warranty may not cover damaged machine parts (e.g. seals and tubes), where the damage can be directly related to the use of non-Struers consumables.

# Declaration of Conformity

Doc:  
16177901 F

**Struers ApS**  
Pederstrupvej 84  
DK-2750 Ballerup, Denmark

EU / UE / EL / EC / EE / ES / EÚ / AB

**Manufacturer** / Производител / Výrobce / Producent / Hersteller / Κατασκευαστής / Fabricante / Tootja / Valmistaja / Fabricant / Proizvodač / Gyártó / Fabricante / Gamintojas / Ražotājs / Fabrikant / Producent / Fabricante / Producătorul / Výrobca / Proizvajalec / Tillverkare / 販売元 / 製作者 / Produsent / Изготовитель / Ímalatçı / 製造商

Декларация за съответствие  
Prohlášení o shodě  
Overensstemmelseserklæring  
Konformitåtsklärung  
Δήλωση συμμόρφωσης  
Declaración de conformidad  
Vastavusdeklaratsioon

Vaatimustenmukaisuusvakuutus  
Déclaration de conformité  
Izjava o skladnosti  
Megfelelőségi nyilatkozat  
Dichiarazione di conformità  
Atitikties deklaracija  
Atbilstības deklarācija

Verklaring van overeenstemming  
Deklaracija zgodności  
Declaração de conformidade  
Declarație de conformitate  
Vyhlášení o zhode  
Izjava o skladnosti  
Intyg om överensstämmelse

適合宣言書  
적합성 선언서  
Samsvarserklæring  
Заявление о соответствии  
Uygunluk Beyanı  
符合性声明

**Name** / Име / Název / Navn / Name / Όνομα / Nombre / Nimetus / Nimi / Nom / Naziv / Név / Nome / Pavadinimas / Nosaukums / Naam / Nazwa / Nome / Denumirea / Názov / Ime / Namn / 名前 / 제품명 / Наименование / Adı / 名称  
Accutom-100

**Model** / Модел / Model / Model / Modell / Μοντέλο / Modelo / Mudel / Malli / Modèle / Model / Modell / Modello / Modelis / Modelis / Model / Model / Modelo / Modelul / Model / Model / Modell / モデル / 모델 / Modell / Модель / Model / 型号  
Accutom-100

**Function** / Функция / Functie / Funktion / Funktion / Λειτουργία / Función / Funktsioon / Toiminto / Fonction / Funkcija / Funkció / Funzione / Funkcija / Funkcija / Functie / Funkcja / Função / Functja / Funkcia / Funkcija / Funktion / 機能 / 기능 / Funksjon / Назначение / Fonksiyon / 功能  
Precision Cut-off Machine/Grinding Machine

**Type** / Тип / Тур / Type / Тур / Τύπος / Tipo / Tüüp / Турпи / Type / Tip / Tipus / Tipo / Tipas / Tips / Type / Тур / Tipo / Tipul / Тур / Тип / Тур / 種類 / 유형 / Type / Тип / Tür / 类型  
06176227

**Serial no.** / Серийн номер / Výrobní číslo / Seriennummer / Seriennummer / Σειριακός αριθμός / N.º de serie / Seerianumber / Sarjainno / No de série / Serijski broj / Sorozatszám / N. seriale / Serijos Nr. / Sērijas Nr. / Serienr. / Numer serjny / N.º de série / Nr. serie / Výrobné č. / Serijska št. / Seriennummer / シリアル番号 / 일련번호 / Serienr. / Серийный номер / Seri no. / 序列号



Module H, according to global approach

en	We declare that the product mentioned is in conformity with the following directives and standards:	el	Δηλώνουμε ότι το εν λόγω προϊόν είναι σύμφωνο με τις ακόλουθες οδηγίες και πρότυπα:	hu	Kijelentjük, hogy jelen termék megfelel a következő irányelveknek és szabványoknak:	pt	Declaramos que o produto mencionado está em conformidade com as seguintes normas e diretivas:	ko	해당 선언서 상의 제품은 다음 지침 및 기준에 적합함을 선언합니다.
bg	Декларираме, че посоченият продукт е в съответствие със следните директиви и стандарти:	es	Declaramos que el producto mencionado cumple con las siguientes directivas y normativas:	it	Dichiariamo che il prodotto citato è conforme ai seguenti standard e direttive:	ro	Declarăm că produsul menționat este în conformitate cu următoarele directive și standarde:	no	Vi erklærer at produktene som er nevnt er i samsvar med følgende direktiver og standarder:
cs	Tímto prohlašujeme, že uvedený výrobek je v souladu s následujícími směrnici a normami:	et	Kinnitame, et nimetatud toode vastab järgmistele direktiividele ja standarditele:	lt	Pareiškiamo, kad nurodytas gaminyso atitinka šias direktyvas ir standartus:	sk	Vyhlasujeme, že uvedený výrobok je v súlade s týmito smernicami a normami:	ru	Настоящим заявляем, что указанная продукция отвечает требованиям перечисленных далее директив и стандартов:
da	Vi erklærer herved, at det nævnte produkt er i overensstemmelse med følgende direktiver og standarder:	fi	Vakuutamme, että mainuttu tuote on seuraavien direktiivien ja standardien mukainen:	lv	Mēs apstiprinām, ka minētais produkts atbilst šādām direktīvām un standartiem:	sl	Potrdujemo, da je omenjeni izdelek v skladu z naslednjimi direktivami in standardi:	tr	Belirtilen ürünün aşağıdaki direktiflere ve standartlara uygun olduğunu beyan ederiz:
de	Wir erklären, dass das genannte Produkt den folgenden Richtlinien und Normen entspricht:	fr	Nous déclarons que le produit mentionné est conforme aux directives et normes suivantes :	nl	Wij verklaren dat het vermelde product in overeenstemming is met de volgende richtlijnen en normen:	sv	Vi intygar att den angivna produkten överensstämmer med följande direktiv och standarder:	zh	我们特此声明上述产品符合以下指令和标准:
		hr	Izjavljujemo da je spomenuti proizvod sukladan sljedećim direktivama i standardima:	pl	Oświadczamy, że wymieniony produkt jest zgodny z następującymi dyrektywami i normami:	ja	弊社はこの指定製品が以下の指令および基準に適合することを宣言します。		

**2006/42/EC** EN ISO 12100:2010, EN ISO 13849-1:2015, EN ISO 13849-2:2012, EN ISO 13850:2015, EN ISO 13857:2017, EN ISO 16089:2015, EN 60204-1:2018

**2014/30/EU** EN 61000-3-2:2014, EN 61000-3-3:2013, EN 61000-6-2:2005/Corr:2005, EN 61000-6-3:2007/A1:2011/A1-AC:2012

**2011/65/EU**  
**2015/836** EN 63000:2018

**1907/2006/EU**

**Additional standards** NFPA 79:2021, FCC 47 CFR part 15 subpart B:2021

Authorized to compile technical file/

Authorized signatory:

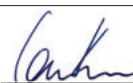

Claus Kappe  
VP Operations

Date







Pederstrupvej 84  
DK-2750 Ballerup  
Denmark